



Endocrine Control of the Reproductive Activity in Hibernating Bats

Author: Kawamoto, Keiichi

Source: Zoological Science, 20(9) : 1057-1069

Published By: Zoological Society of Japan

URL: <https://doi.org/10.2108/zsj.20.1057>

BioOne Complete (complete.BioOne.org) is a full-text database of 200 subscribed and open-access titles in the biological, ecological, and environmental sciences published by nonprofit societies, associations, museums, institutions, and presses.

Your use of this PDF, the BioOne Complete website, and all posted and associated content indicates your acceptance of BioOne's Terms of Use, available at www.bioone.org/terms-of-use.

Usage of BioOne Complete content is strictly limited to personal, educational, and non - commercial use. Commercial inquiries or rights and permissions requests should be directed to the individual publisher as copyright holder.

BioOne sees sustainable scholarly publishing as an inherently collaborative enterprise connecting authors, nonprofit publishers, academic institutions, research libraries, and research funders in the common goal of maximizing access to critical research.

[REVIEW]

Endocrine Control of the Reproductive Activity in Hibernating Bats

Keiichi Kawamoto*

Department of Biology, Faculty of Science, Toyama University, Gofuku, Toyama 930-8555, Japan

ABSTRACT—Bats, Chiroptera, constitute the second largest order of the class Mammalia and vary greatly in habitats, available foods and mating systems. The timing, duration and patterns of reproduction in bats vary considerably among species and different localities. Though much is known about the reproductive phenomena and associated endocrine characteristics of various species, the central mechanism regulating the peculiar delay and asynchrony in reproductive activity remains to be elucidated. The current understanding on the endocrine characteristics and possible mechanism of regulation of the hypothalamo-adenohypophysial-gonadal axis of bats will be reviewed, based mainly on our own studies in hibernating rhinolophid bats.

Key words: reproduction, bat, hypothalamus, pituitary, gonad

INTRODUCTION

Bats, Chiroptera, constitute the second largest order of mammals next to rodents (about 960 species in the world). In the tropical region, they are extremely abundant in the number of species and their population probably exceed that of rodents. Bats also vary greatly in terms of habitat, available foods (nectar to blood) and mating systems (Altringham, 1996; McCracken and Wilkinson, 2000). In general, although echo location and hibernation are well known in bats as well as some species of mammals, unique reproductive patterns are also documented in bats (Gustafson, 1979; Oxberry, 1979; Racey and Entwistle, 2000). One unusual reproductive feature is the delay of ovulation and fertilization. This phenomenon is not confined to bats but it has been found in several species of rodents. A second feature is the delayed implantation of the embryo. This is popular among numerous mammalian species, particularly in carnivores (Clarke, 1981). The retention time of viable spermatozoa within the female reproductive tract is very limited. The mature follicle is not maintained for long period in the ovary, and after the maturation the follicle is ovulated naturally or through the stimulation of copulation. These reproductive patterns with interruption for a long

period by hibernation are characteristic to bats inhabiting the temperate zones, the pattern not occurring in other mammalian hibernators. A third unique feature is the delayed development of embryo. This phenomenon is observed in bats living in the tropical and subtropical zones (Fleming, 1971; Heideman, 1989).

In the temperate zone, most species of bats are insectivorous and display a restricted seasonal monoestrus with copulation occurring in autumn. In males of most species, spermatogenesis peaks in summer, but mating behavior and the maximal development of accessory organs are delayed until autumn (Gustafson, 1979; Racey and Entwistle, 2000). Female bats hibernate with spermatozoa stored in their reproductive tracts; oviducts in most species (delayed ovulation/fertilization type) or at the early pregnant stage with unimplanted blastocysts in their uteri (delayed implantation type) for about five months until the next spring. After arousal in spring, ovulation/fertilization and implantation occur in bats exhibiting the delayed ovulation and implantation patterns, respectively (Oxberry, 1979). Female bats form a maternity colony and begin parturition (monotocous in most species) and lactation during summer. This timing coincides with peak food availability, which is likely to maximize reproductive success. After weaning, mother bats take food to reserve energy in the body, mostly in the form of fat, for the preparation for the next hibernation. Before hibernation, mature female bats enter estrus and copulate with males. Thus, bats inhabiting the temperate zone show

* Corresponding author: Tel. +81-76-445-6636;
FAX. +81-76-445-6641.
E-mail: kawamoto@sci.toyama-u.ac.jp

a unique reproductive activity prior to hibernation (Racey, 1982), which attracted much attention of the investigators. However, the reproductive phenomena and associated endocrine function have been documented in a few species, and the majority of such studies are, if any, fragmentary. The aim of this article is to review the present status of research on reproductive function including our own findings in rhinolophid bats.

Annual reproductive cycle

Annual reproductive cycle of bats inhabiting the temperate zones fundamentally follows the two patterns, delayed ovulation/fertilization and delayed implantation (Fig. 1). In the islands of Japan, Japanese house bats, *Pipistrellus abramus* (Vespertilionidae), horseshoe bats, *Rhinolophus ferrumequinum* (Rhinolophidae) and *Myotis macrodactylus* (Vespertilionidae) exhibit the former type (Uchida and Mōri, 1987) (Fig. 1A). In male bats corresponding to this pattern of females, a seasonally separated asynchrony between testicular function and mating behavior is noted. The latter pattern is found in certain species of the vespertilionid genus *Miniopterus* and rhinolophid genus *Rhinolophus* (Oxberry, 1979). A long-fingered bat, *Miniopterus fuliginosus* (Vespertilionidae) exhibits the latter pattern (Fig. 1B). Reproductive cycles of other species living in Japan remain unknown.

Hypothalamus

Seasonal changes of the hypothalamic neuropeptides

in mammalian hibernators, especially the changes of neuropeptide-producing cells associated with hibernation, have been reported in hedgehogs, hamsters, dormice and ground squirrels (Nürnberg, 1995). Though there are several reports on the hypothalamic neuropeptides in bats (Mikami *et al.*, 1988b; Anthony *et al.*, 1991), detailed analyses have only been performed on gonadotropin-releasing hormone (GnRH). GnRH is the key hypothalamic hormone responsible for the regulation of reproductive function. GnRH stimulates the pulsatile release of follicle-stimulating hormone (FSH) and luteinizing hormone (LH) from gonadotrophs in the pars distalis. Although the amino acid sequence of this decapeptide is basically conserved among mammalian species, the presence of a variant with three amino acid substitutions (chicken GnRH II) is documented in several metatherian and early-evolved eutherian species. However, only the mammalian GnRH is identified in the bat (*Myotis lucifugus*) brain (King *et al.*, 1994).

In seasonal breeding mammals, gonadal activity depends on environmental factors, especially photoperiod. In long-day breeding rodents, such as hamsters, animals exposed to short-day photoperiods in captivity or to naturally declining day lengths show a decline in gonadal function concomitant with a decrease in the release of hypothalamic GnRH (Pickard and Silverman, 1979; Pieper, 1984; Glass, 1986; Kriegsfeld and Nelson, 1999; Kawamoto *et al.*, 2000b) and gonadotropins (Turek *et al.*, 1975; Tamarkin *et al.*, 1976; Pickard and Silverman, 1979; Simpson *et al.*, 1982;

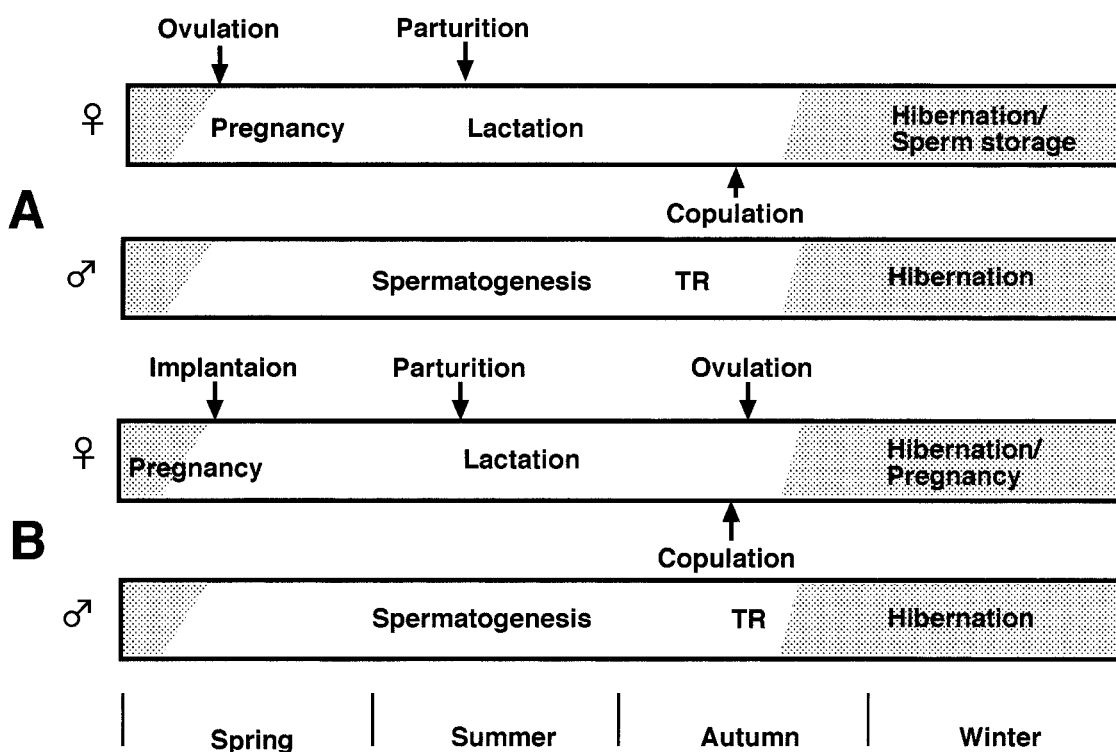

Fig. 1. Annual reproductive cycle of bats showing delayed ovulation/fertilization in females and the corresponding pattern in males (A), and delayed implantation in females and the corresponding pattern in males (B). TR: testicular regression. Modified from Kawamoto *et al.*, 1998 and Oxberry, 1979.

Yellon and Goldman, 1987; Niklowitz *et al.*, 1989). In mammals, the effect of photoperiod is mediated by the nocturnal secretion of melatonin from the pineal gland, but the exact mechanism of neuroendocrine regulation by which photoperiod causes physiological adjustments remains unknown (Malpoux *et al.*, 2001).

In rodent species, hypothalamic GnRH neuronal cell bodies are preferentially distributed rostrally, within the diagonal band of the Broca, the preoptic area and the anterior hypothalamic area, particularly in the medial preoptic area which is the major source of GnRH neuronal terminals in the median eminence, the release site of GnRH to the adenohypophysis (Silverman *et al.*, 1979; Jennes and Stumpf, 1980; Witkin *et al.*, 1982). In contrast, the majority of GnRH neuronal perikarya in vespertilionid bats, *Myotis lucifugus* (King *et al.*, 1984), *M. macrodactylus* (Kawamoto, unpublished data), *Miniopterus shreibersii* (Mikami *et al.*, 1988b; Fernández *et al.*, 1992) and *Eptesicus fuscus* (Oelschläger and Northcutt, 1992) are located in the medial basal hypothalamus, particularly in the region of the arcuate nucleus, and their distribution well resembles that in higher primates (Parker *et al.*, 1980; Silverman *et al.*, 1982). These GnRH neurons are fusiform-shaped or bipolar with a smooth outline in bats. Further analyses of the GnRH neuronal system in relation to the season and reproductive function have only been documented in a few species of bats (Anthony *et al.*, 1989; Fernández *et al.*, 1992). We have studied seasonal changes and sex difference in the hypothalamic GnRH neurons of rhinolophid bats, *R. ferrumequinum* (Kawamoto *et al.*, 1998). Although GnRH-immunoreactive neurons in this species were encountered in the area from the diagonal band of the Broca to the mammillary body, they were concentrated in the medial preoptic area and medial basal hypothalamus. This distribution seems to be a characteristic feature of rhinolophid bats, which is not found in vespertilionid bats. In rhinolophid bats, the seasonal changes in the number and immunoreactivity of GnRH neurons were greater in the medial basal hypothalamus than in the medial preoptic area. These results suggest that the GnRH neuronal activity in the medial basal hypothalamus is more closely associated with the reproductive function of this bat than that in the medial preoptic area. Furthermore, alterations of GnRH-immunoreactive neurons in the medial basal hypothalamus are closely related with the density of GnRH-immunoreactive fibers in the median eminence. In vespertilionid bats, numbers of GnRH-immunoreactive neurons in the medial basal hypothalamus also vary depending on the reproductive state (Anthony *et al.*, 1989; Fernández *et al.*, 1992; Anthony, 2000). These findings, therefore, suggest that GnRH neurons located in the medial basal hypothalamus are the main perikarya of GnRH terminals in the median eminence and play a central role in the seasonal changes of gonadotropin secretion in both rhinolophid and vespertilionid bats. Our study in rhinolophid bats revealed a sex difference in the number of GnRH neurons in the medial preoptic nucleus in early June to late July. The number of

immunoreactive neurons located in the medial preoptic nucleus was significantly less in females than males. From May to August, pregnancy, parturition and lactation occur in mature female bats, and therefore enhanced GnRH neuronal activity in the medial preoptic area may be related to female-specific reproductive events.

King *et al.* (1984) reported in female vespertilionid bats (*M. lucifugus*) that GnRH neurons innervate not only to the median eminence but also the pars nervosa. They pointed out that immunoreactive GnRHs in the pars nervosa were chemically identical with those in the hypothalamus (Anthony *et al.*, 1987) and immunoreactivity was significantly reduced in the pars nervosa as well as in the hypothalamus and median eminence during periovulatory period (Anthony *et al.*, 1989). These parallel reduction of GnRH associated with ovulation suggests that the neural lobe component of the system contributes to the control of gonadotropin secretion in this bat. These findings indicate that multiple release sites may be present in the median eminence, infundibular stalk and neural lobe for the delivery of GnRH to the bat anterior pituitary (Anthony *et al.*, 1984, 1989). However, the innervation of GnRH terminals into the pars nervosa has not been reported in other species of bats.

Adenohypophysis

The adenohypophysis is divided into the pars distalis, pars intermedia and pars tuberalis. However, to our knowledge there are no reports on the pars intermedia in bats.

(1) Pars Distalis

As in other mammalian species, six kinds of hormones and five kinds of hormone-secreting cells exist in the pars distalis of bats. Most findings on the function of hormone-producing cells have been made using immunohistochemistry with heterologous antisera as follows. During the arousal period, thyrotrophs show the increased activity (Anthony and Gustafson, 1984b). Annual changes in corticotrophs are related to the so-called fat cycle in tropical vespertilionid bats (Singh and Krishna, 1996b). In vespertilionid bats inhabiting the temperate zone, there were no seasonal variations in somatotrophs (Anthony *et al.*, 1991). In several species of bats inhabiting the temperate zone or tropical zone, immunohistochemical studies have also verified changes in mammatrophs (lactotrophs) relating to reproductive cycle and seasonality (Richardson, 1981b; Jemenez *et al.*, 1987; Mikami *et al.*, 1988a; Ishibashi and Shiino, 1989; Muñoz *et al.*, 1991; Singh and Krishna, 1996a). In rhinolophid bats, granular cells showing proliferative activity in the pars distalis were identified as mammatrophs in both sexes (Fig. 2). Mammatrophs occupy more hypophysial area in early summer (pregnant period) and mid-summer (lactation period) than in other seasons, suggesting that hypophysial prolactin (PRL) contents in female bats were elevated during these periods (Fig. 2A). In the male the seasonal variation is not distinct. Similar changes have been reported in several species of vespertilionid bats (Jemenez *et al.*, 1987; Mikami *et al.*, 1988a; Singh and Krishna,

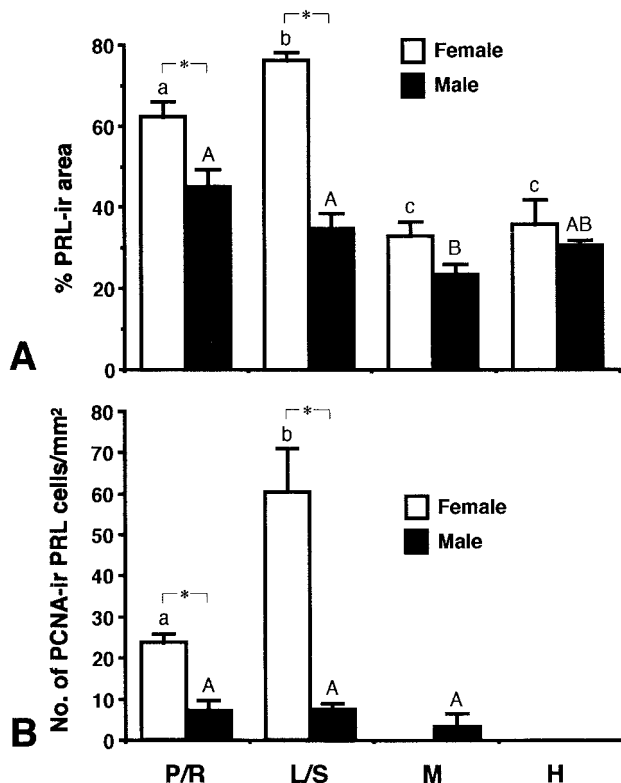

Fig. 2. Seasonal changes of PRL-immunoreactive (ir) cells (mammotrophs) in the pars distalis of adult bats, *R. ferrumequinum*. (A) Percentage of area occupied by PRL cells. (B) Number of PRL-ir cells showing proliferative activity per unit area. The section was doubly immunostained with anti-ovine PRL and anti-proliferating cell nuclear antigen (PCNA) sera. P: pregnant period (mid-June), R: recrudescence period (mid-June), L: lactating period (late July), S: spermatogenic period (early August), M: mating period (mid-October), H: hibernating period (January). Each column and vertical line represent the mean \pm SEM. Data with different letters above the columns are significantly different from one another, $p < 0.05$. Asterisks represent significant differences between males and females, $p < 0.05$.

1996a). Proliferative activity of mammotrophs in females was detected in early summer (pregnant period) and mid-summer (lactating period), but not in other seasons (Fig. 2B). In male bats, this activity was low and continued throughout the year except in winter (hibernation period). It has been well established that a direct estradiol action on mammotrophs is required for the hypertrophy and proliferative activity of these cells (e.g. Lloyd *et al.*, 1975), indicating increased steroidogenesis in female bats during summer.

The presence of mammosomatotrophs, bihormonal cells that secrete both PRL and growth hormone (GH), has been well documented in the pars distalis of various mammals during fetal, pregnant and lactating periods, and in human pituitary adenomas (Mulchahey and Jaffe, 1988; Kineman *et al.*, 1991; Nikitovitch-Winer *et al.*, 1987; Li *et al.*, 1993). Ishibashi and Shiino (1989) have demonstrated the presence of mammosomatotrophs in the pars distalis of Japanese house bats (*P. abramus*, Vespertilionidae) by immunoelectron microscopy. Based on their findings, mam-

mosomatotrophs were classified into the following four cell types: 1) only mixed granules containing both PRL and GH, 2) mixed and PRL granules, 3) mixed, PRL and GH granules, and 4) mixed and GH granules. These cells exist throughout the annual cycle, while mammotrophs containing pure PRL granules appear only during pregnancy and lactation. From these findings, it was concluded that mammosomatotrophs, which constantly exist throughout the annual cycle, probably function as stem cells which have the potential to differentiate into mammotrophs. In rhinolophid bats, though mammosomatotrophs in female hypophysis were detected during lactation and pregnancy, mammotrophs containing only PRL were also observed in all seasons (Kawamoto, unpublished data). Thus, the appearance of pure PRL cells relating to reproductive function in female bats shows species variation. Though the role of mammosomatotrophs is not completely understood, several attempts have been made to explain their physiological significance (Takahashi, 1995).

Owing to a lack of purified bat adenohypophysial hormones and specific antisera against these hormones, there have been only a few reports on the blood level of hypophysial hormones in the bat. O'Brien *et al.* (1996) measured plasma PRL concentrations in male and female megachiropteran bats using a heterologous assay. They reported that circulating PRL levels and hypophysial PRL contents were higher in females than males, and that these levels were high during pregnant and lactating periods, declining as breeding began in autumn. These findings are consistent with the results of previous immunohistochemical studies (Jemenez *et al.*, 1987; Mikami *et al.*, 1988a). From the fact that circulating PRL levels are influenced by dopaminergic agents, O'Brien *et al.* (1996) further concluded that PRL levels play roles in the reproductive physiology of bats, as in other mammalian species, under dopaminergic regulation.

On the other hand, close relationship between circulating PRL levels and delayed implantation in vespertilionid bats is discussed by Anthony (2000). Mammotrophic activities and PRL levels were constantly low during follicular development and the early period of delayed implantation, and these functions and levels increased when the delay came to an end and implantation occurred (Anthony, 2000). According to Bernard and Bojarski (1994), the exogenous treatment of PRL induces the onset of implantation in pregnant female bats, *M. schreibersii* showing delayed implantation pattern, which results in the elevated progesterone (P) levels. While, human chorionic gonadotropin stimulates luteal steroidogenesis, but did not induce implantation. These results may show that elevated synthesis and secretion of PRL activate the corpus luteum and induce the initiation of implantation (Bernard and Bojarski, 1994).

Seasonal changes of gonadotrophs associated with the annual reproductive cycle have been studied by immunocytochemistry in many species of bats (Richardson, 1979, 1981a; Anthony and Gustafson, 1984a; Anthony, 1987; Mikami *et al.*, 1988a; Bernard *et al.*, 1991ab; Singh and

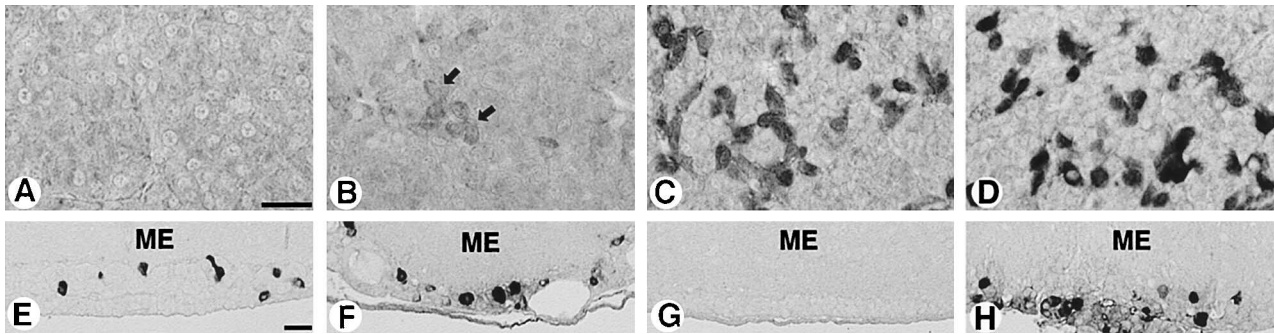

Fig. 3. Photomicrographs of FSH β -ir cells in the pars distalis (horizontal plane) of female adult bats (A–D) and LH β -ir cells in the pars tuberalis (frontal plane) of male adult bats (E–H). The section was immunostained with anti-rat FSH β serum or anti-rat LH β serum. A : pregnant period (mid-June), B: lactating period (late July), C and G: mating period (mid-October), D and H: hibernating period (January), E: recrudescence period (mid-June), and F: spermatogenic period (early August). ME: median eminence. Each bar represents 20 μ m. Arrows in B indicate weakly stained FSH β -ir cells. Note the absence of cells immunostained with antisera in A and G.

Krishna, 1996a; Kawamoto *et al.*, 2000a). Our studies of rhinolophid bats of both sexes verified that the immunoreactivity and size of LH β - and FSH β -immunoreactive cells varied significantly throughout the seasons (Fig. 3A–D). These seasonal variations are considerably greater in females than in males (Fig. 4) as pointed out previously (Anthony, 1987). In reproductively active periods (August), both LH β - and FSH β -immunoreactive cells became hypertrophied and showed weaker immunoreactivity. In female bats, FSH β -immunoreactivity became undetectable during the pregnant period (mid-June), suggesting the need of FSH (Fig. 3A). In contrast to pregnant and lactating periods, in the mating season (mid-October) FSH β -immunoreactivity and cell size returned to near winter values (hibernation period, January) (Figs. 3C, D and 4). Such a reciprocal relation between the immunoreactivity and cell size of gonadotrophs in both sexes may reflect seasonal differences in the dynamics of secretion, storage and synthesis of these hormones during

the annual reproductive cycle. These findings are consistent with previous results in other species of bats (Anthony and Gustafson 1984a; Bernard *et al.*, 1991a; Mikami *et al.*, 1988a; Singh and Krishna, 1996a). Such analyses are useful for evaluating the functional status of gonadotrophs in the pars distalis, but do not yield information on the variation in the rate of hormonal secretion and in the responsiveness to secretagogues.

Substances secreted from endocrine cells can be detected at the single cell level using a reverse hemolytic plaque assay (Smith *et al.*, 1986) or cell immunoblot assay (Arita, 1993). The cell immunoblot assay can sensitively examine not only the incidence of secreting cells in the total cell population, but the amount of substances secreted from a single cell or from a cell population. The function of gonadotrophs in the pars distalis is controlled by the action of hypothalamic GnRH, sex steroids and glycoprotein hormones of gonadal origin. Then, we examined seasonal changes in the gonadotropin secretion and the responsiveness of gonadotrophs to GnRH in male rhinolophid bats by employing the method described above (Fig. 5). We found that the seasonal variations in the total amount of gonadotropins secreted from gonadotrophs per unit volume of chamber were considered due to the changes in gonadotropin secretion per cell and in the number of gonadotropin-secreting cells (Kawamoto *et al.*, 2000a). The total amount of LH secreted from gonadotrophs was marked in spermatogenic and mating periods but extremely small in other phases (post-arousal period, mid-May, and hibernation period, late January). Changes in the total amount of FSH secreted were similar to those in LH secretion. GnRH significantly increased the total amount of gonadotropin secreted from gonadotrophs throughout the annual reproductive cycle except for LH in the post-arousal period and FSH in the hibernation period. In particular, the effect of GnRH on the secretion of both hormones was markedly enhanced during the spermatogenic period. Thus, the responsiveness of gonadotrophs to GnRH also shows seasonal variations, which may be closely associated with the number of GnRH

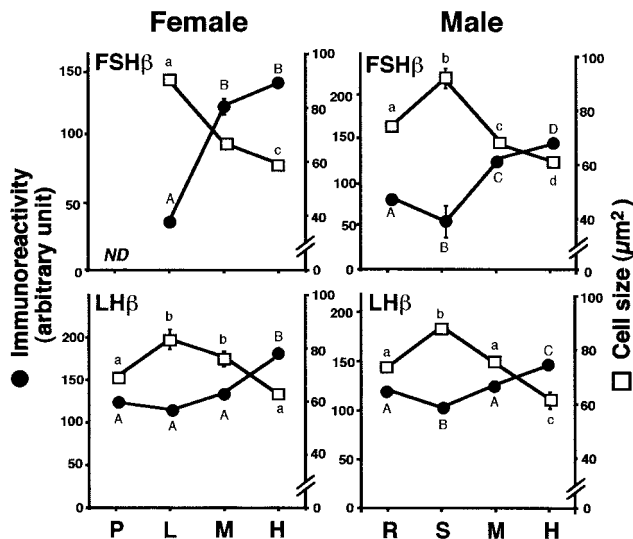

Fig. 4. Seasonal changes in cell size and immunoreactivity in the pars distalis of female and male adult bats. ND: no detection. Other explanations are the same as for Fig. 2.

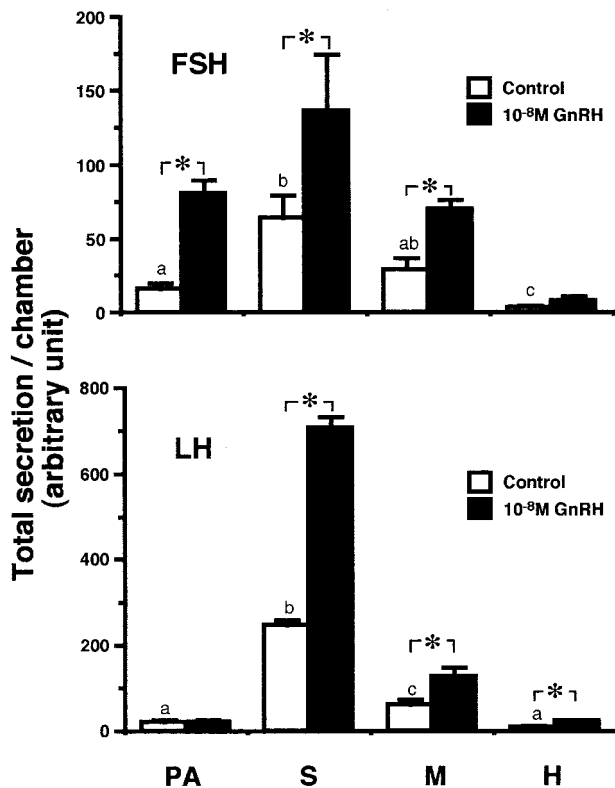

Fig. 5. Seasonal changes in the total amount of gonadotropin secreted from gonadotrophs per unit area of the transfer membrane. A enzymatically dissociated cell suspension was collected from the pars distalis of male adult bats and incubated for 3 hr at 37°C in an atmosphere of 95% air and 5% CO₂. PA: post-arousal period (mid-May). Asterisks represent significant differences between control and stimulated groups, $p < 0.05$. Other explanations are the same as for Fig. 2. Reprinted from Kawamoto *et al.* (2000a) with permission from Wiley-Liss, Inc.

receptors on gonadotrophs and/or with the increased response of gonadotrophs to GnRH caused by the action of gonadal steroids (Conn, 1994; Turzillo *et al.*, 1998; Kawakami and Winters, 1999). In the hibernation period, the majority of gonadotrophs were composed of non-releasable cells but a slight secretory response of gonadotrophs to GnRH was detected at low incubation temperature (10°C, Kawamoto *et al.*, 2000a). These results suggest that the GnRH receptor and subsequent post-receptor events that regulate the action of GnRH on gonadotropin secretion do not completely disappear under heterothermic conditions during hibernation. The secretion of FSH is controlled by glycoproteins (inhibin, activin and follistatin) of gonadal origin in addition to hypothalamic GnRH. However, there are no data available on the effects of these glycoproteins for FSH secretion in bats.

By radioimmunoassay using antiserum to ovine LH, Bernard *et al.* (1991b) have reported the changes in circulating LH levels during delayed implantation in long-fingered female bats (*M. schreibersii*). Although this cosmopolitan species usually hibernates during winter in temperate zones (Mikami *et al.*, 1988a; Fernández *et al.*, 1992), the species

in South Africa studied by Bernard *et al.* (1991b) remains active and enters daily torpor only during very cold periods. They found that plasma LH levels were the highest during follicular development and peaked just before ovulation (April), suggesting that the LH surge is required for the initiation of ovulation as in other mammalian species. Plasma levels then dropped rapidly during early delayed implantation (May), beginning to rise again prior to the end of the delay period (August). After implantation, LH levels continued to increase, again reaching a peak in late pregnancy (November). This peak coincides with the maximal level of circulating plasma P throughout the year. Thus, these findings clearly demonstrate that there are close relationships between low LH levels and delayed implantation, resulting in the inhibition of luteal activity during delayed implantation.

(2) Pars Tuberalis

The pars tuberalis of the adenohypophysis covers both the median eminence and the infundibular stalk as thin layers of cells, which is a main target site for melatonin secreted by the pineal gland (Vanecek, 1988; Wittkowski *et al.*, 1999) and may be involved in photoperiodic regulation of endocrine systems in seasonally breeding mammals (Goldman and Darrow, 1983; Hazlerigg *et al.*, 2001; Malpoux *et al.*, 2001). The cells in the pars tuberalis are usually classified into three types, that is, pars tuberalis-specific cells, folliculo-stellate cells and granular endocrine cells (Wittkowski *et al.*, 1999; Hazlerigg, 2001). In several mammals, most of the granular endocrine cells in the pars tuberalis can be identified as gonadotrophs and thyrotrophs (Hazlerigg, 2001). However, there is little information available about the functional roles of these cells and the regulatory mechanism of their hormonal secretion.

We found that gonadotrophs (FSH β - or LH β -immunoreactive cells) were distributed throughout the pars tuberalis in hamsters. However, gonadectomy in hamsters induced the hypertrophy and decreased the immunoreactivity of gonadotrophs in the pars distalis, whereas no alterations were detected in gonadotrophs of the pars tuberalis. By employing Western blotting and radioligand binding assay, we furthermore clarified that the concentrations of estrogen receptors and GnRH receptors were far lower in the pars tuberalis than in the pars distalis. Removal of the negative feedback action of estradiol produces a well-known increase in gonadotropin secretion and gonadotropin β -subunit mRNA levels, and resulted in considerable hypertrophy of gonadotrophs in the pars distalis. Such a negative feedback action of estradiol in the regulation of gonadotrophs is generally thought to be an indirect effect through the hypothalamus, by modifying GnRH pulse generation, because estradiol has no inhibitory effects on FSH and LH release from gonadotrophs, or on gonadotropin β -subunit mRNA expression *in vitro* (Gharib *et al.*, 1990; Marshall *et al.*, 1991). Based on these findings, it is very likely that gonadotrophs in the hamster pars tuberalis are not influenced by the direct (via estrogen receptors) and indirect (via hypothalamic GnRH) feedback actions of estradiol (Kawamoto *et al.*, sub-

mitted). In addition, by employing using RT-PCR assay and *in situ* hybridization we found that exposure to a short-day photoperiod increased the incidence of gonadotropin β mRNA-expressing cells and the level of gonadotropin β mRNA in the hamster pars tuberalis, whereas these were decreased in the pars distalis. These photoperiod-mediated effects were blocked by pinealectomy (Kawamoto *et al.*, 1999; Hozumi and Kawamoto, 2001). Expression of GnRH receptor mRNAs in the pars tuberalis and pars distalis also showed similar changes under different photoperiods. Although the possible role of the expression of gonadotropin genes increased by a short photoperiod remains unknown, the expression is up-regulated by melatonin. Conversely, previous investigators have reported that thyrotropin β gene expression in the hamster pars tuberalis is down-regulated after exposure to a short-day photoperiod (Wittkowski *et al.*, 1999). In our study, the hormonal content of the pars tuberalis was much lower than that of the pars distalis, as pointed out in rats (Chafuen and Cannata, 1979). These hormones in the pars tuberalis were immunologically identical to those in the pars distalis and show the same biological activity (Aguado *et al.*, 1982). However, even if these hormones are released from the pars tuberalis, the amounts are too small to have much influence on target organs. More recent studies have revealed that the pars tuberalis secreted substances influencing the function of the pars distalis; unidentified tuberalin or 21 and 72kDa proteins (Guerra and Rodríguez, 2001; Stirland *et al.*, 2001). Thus, the hypothesis that melatonin acts on cells in the pars tuberalis to regulate the production of an as yet unidentified substances may attract attention.

The presence of gonadotrophs in the bat pars tuberalis was first reported by Mikami *et al.* (1988a). In their report, LH β -immunoreactive cells in the pars tuberalis were identified only in long-fingered bats by immunohistochemical analysis. In male rhinolophid bats, we found that LH β -immunoreactive cells were distributed throughout the pars tuberalis and their immunoreactivity varied among seasons (Fig. 3E–H). No other glycoprotein hormones were detected in the pars tuberalis of this species, although the use of antisera against other adenohipophysial hormones might identify the presence of other hormones in the pars distalis. LH β -immunoreactive cells in the pars tuberalis were encountered during early summer (recrudescent period) and mid-summer (spermatogenic period), but were not detected in autumn (mating period, Fig. 3G). These immunoreactive cells appeared again in winter (hibernation period, Fig. 3H). These observations show the seasonal variation in the secretory activity of LH β in these cells, indicating that secretion of LH β from the pars tuberalis is increased in autumn. Whether seasonal changes in LH β immunoreactivity in the pars tuberalis are associated with gonadal activity, reproductive behavior or any specific environmental cues, such as photoperiod, remains to be elucidated.

Gonads

Gonadal steroids play various roles in the pars distalis, including cell proliferation and the regulation of hormone synthesis. Therefore, successful reproduction is critically dependent on the gonadal steroid feedback system. In bats, commonly measured steroid hormones are testosterone (T), P and estradiol (E) (Martin and Bernard, 2000), but no data are available for circulating glycoproteins of gonadal origin.

(1) Testicular function

Reproductive cyclicity in male bats inhabiting temperate latitudes can be classified into two patterns based on the timing and duration of testicular function (spermatogenesis in the testis and T production), the development of accessory sex organs and libido. Regardless of species, active spermatogenesis occurs during summer, which coincides with maximum development of the testes and the peak of circulating T levels.

First, asynchrony in activity between testes and accessory sex organs is noted in many species of bats. In these species, although the increase in testicular weight, spermatogenesis and the activity of Leydig cells occurs in summer, the development of accessory organs and mating behavior is retarded until autumn, by which time the testes have slightly or considerably regressed, the epididymides are full of spermatozoa, and the accessory sex organs show maximal development. Numerous spermatozoa stored within the epididymides remain after copulation throughout winter in both hibernating and nonhibernating species. Such asynchrony has been reported in vespertilionid bats, *M. lucifugus*, *Nyctalus noctula* and *Vespadelus vulturnus*, and rhinolophid bats, *R. ferrumequinum* and *R. capensis* (Gustafson, 1979; Bernard, 1986; Martin and Bernard, 2000). This pattern of the male corresponds to the female pattern of delayed ovulation (Gustafson, 1979). In our study of *R. ferrumequinum*, after the arousal from hibernation, spermatogenesis started in mid-June and peaked in August, which is accompanied by the increase in testicular weight and circulating T levels (Fig. 6 A). In the mating period (mid-October), mature spermatozoa are full in the seminiferous tubules. Leydig cells are atrophic. Testicular weight and circulating T levels also decline in this season (Fig. 6A), and the accessory sex organs maximally develop in this period (Gustafson, 1979). For the peripheral endocrine mechanism on the asynchronous recrudescence between testis and the accessory sex organs, Gustafson and Damassa (1984, 1985) have pointed out that the increase in steroid binding globulin (SBG) produces high circulating T levels during spermatogenesis and inhibits the hypertrophy of accessory sex organs by reducing the free T available. Thus, fluctuations in SBG activity may be important factor in the recrudescence of the accessory sex organs.

Second, male reproductive cyclicity is characterized by synchronized activity of the testes and accessory organs in several microchiropterian and many megachiropterian species. This pattern is generally the same as in other mammalian species, where all the male reproductive activities (the

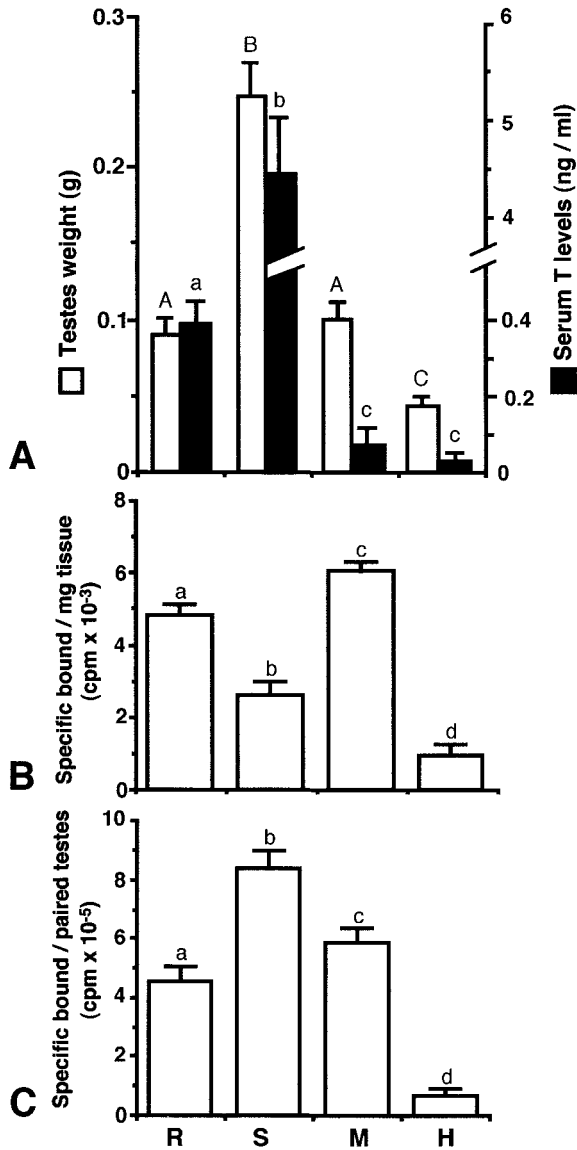

Fig. 6. Seasonal changes in testes weight and serum T concentrations (A) and ^{125}I -FSH-binding per unit tissue weight (B) and per testes (C) in adult bats. Other explanations are the same as for Fig. 2. Reprinted from Hayashi *et al.* (2002) with permission from Wiley-Liss, Inc.

increase in spermatogenesis, testicular mass, circulating T levels and activity of the accessory sex organs) are synchronized. After copulation with a female, these activities decrease, resulting in a regression of testicular mass and accessory organs, and a decline in circulating androgen levels. This pattern has been reported in vespertilionid bats, *M. schreibersii* (Gustafson, 1979; Bernard *et al.*, 1991a) and pteropodid bats, *Pteropus poliocephalus* and *P. scapulatus* (McGuckin and Blackshaw, 1991a, b).

The primary hormonal control of spermatogenesis involves the actions of FSH and T on Sertoli cells, while LH initiates and maintains the steroidogenesis in Leydig cells. Several investigators have reported changes in gonadotropin receptors in the testis during the annual reproductive

cycle in captive wild mammalian species (Calvo *et al.*, 1986; Tsutsui *et al.*, 1989; Howell-Skalla *et al.*, 2000). To our knowledge, however, no data on gonadotropin receptors are available for bats and other mammalian hibernators. In rhinolophid bats, the concentrations of FSH receptors (specific binding per unit tissue weight) and total FSH receptors in the testes varied throughout the annual reproductive cycle (Fig. 6B, C). From scatchard plot analyses, these changes are considered due to variations in the number, not the affinity, of these receptors, as reported previously in other mammalian species (Abou-Isa and Reichert, 1977; Closset *et al.*, 1977; Thanki and Steinberger, 1978; Barenton and Pelletier, 1983; Tsutsui *et al.*, 1985; Calvo *et al.*, 1986; Tsutsui *et al.*, 1988). FSH receptors are primarily localized in Sertoli cells (Simoni *et al.*, 1997) and therefore the decrease in the concentration of FSH binding sites on unit weight basis in summer (spermatogenic period) could be attributed to the dilution effect on Sertoli cells by germ cells. The elevated concentration of binding sites during the mating period is due to a rapid decrease of testicular germ cells, spermatocytes and spermatids, because there is some evidence that the absolute number of Sertoli cells per testis is stable after puberty and does not vary throughout the seasons in mammals (Steinberger and Steinberger, 1977; Sinha Hikim *et al.*, 1988). From the histological examination of bat testis, the density of Sertoli cells per unit testicular weight appears to be considerably higher in the hibernating period than in other periods (Hayashi *et al.*, 2002). Nevertheless, the concentration of binding sites and total binding sites in the testis, and FSH-stimulated production of cAMP (Fig. 7) were very low during hibernation. These results suggest that in the testis in the hibernating period, not only was the number of FSH binding sites per Sertoli cell extremely decreased, but the activity of the adenylate cyclase system led by the FSH-receptor complex was much reduced. LH and FSH secretion and the responsiveness of gonadotrophs to GnRH

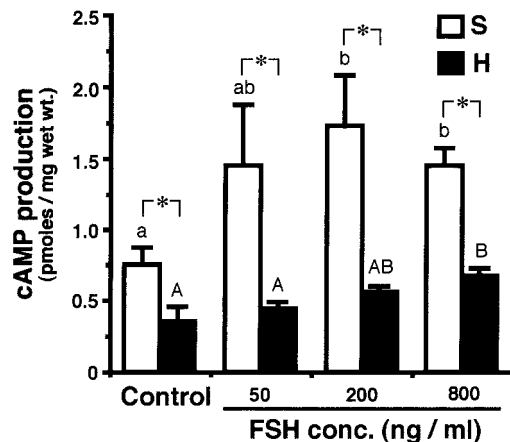

Fig. 7. Dose effect of FSH stimulation on cAMP accumulation in cultured seminiferous tubules in adult bats. Tissue was incubated with shaking for 60 min at 35°C in an atmosphere of 95% air and 5% CO₂. Other explanations are the same as for Fig. 2. Reprinted from Hayashi *et al.* (2002) with permission from Wiley-Liss, Inc.

as assessed by cell immunoblot assay were markedly increased in the spermatogenic period compared to other periods (Fig. 5). Seasonal changes in FSH secretion without a secretagogue paralleled those in the total number of FSH binding sites. Thus, seasonal fluctuations are accompanied by corresponding changes in the responsiveness of testes to FSH, which appear to be due to the secretion of FSH from the pars distalis. Therefore, testicular FSH receptors might be up-regulated in response to elevated circulating FSH levels in bats. After the arousal from hibernation elevated FSH secretion may be required for the initiation of testicular recrudescence and expression of FSH receptors, which seems to be supported by an elevated FSH secretion, and the testicular weight is concomitantly increased during testicular recrudescence in hamsters (Berkowitz and Heindel, 1984; Milette *et al.*, 1988; Schatt *et al.*, 1995).

(2) Ovarian Function

As mentioned above, female bats inhabiting temperate latitudes show unusual reproductive phenomena, a delayed ovulation/fertilization or a delayed implantation that is temporarily interrupted by hibernation during winter (Oxberry, 1979). In vespertilionid and rhinolophid bats showing the former, estrus and copulation occur in late summer or autumn and spermatozoa are stored during winter in the female reproductive tract. In *Antrozonus pallidus*, the ovaries contain a developed Graafian follicle and circulating P levels are relatively low throughout the period, whereas E levels increase temporarily at estrus (Oxberry, 1979). Such low P levels seem to be prerequisite for the maintenance of delayed ovulation. After arousal from hibernation, circulating E levels appear to rise temporarily at ovulation and then decline immediately after ovulation. As the pregnancy proceeds, E levels dramatically increase reaching a peak at mid-pregnancy and a subsequent increase occurs during lactation. Circulating P levels also increase after the arousal, particularly with the development of the corpus luteum after ovulation. In this period, 3β -hydroxysteroid dehydrogenase and 17β -hydroxysteroid dehydrogenase, enzymes necessary for converting to P and E respectively, are strongly expressed in the interstitial tissue and corpus luteum (Oxberry, 1979). At the early stage of pregnancy, P levels temporarily decline and then increase considerably to reach a peak prior to parturition. Changes of these steroidal levels are similar in several other species showing a delayed ovulation/fertilization pattern, such as *M. lucifugus* (Buchanan and Younglai, 1986, 1988) and *Chalinolobus gouldii* (Hosken *et al.*, 1996).

As to the delayed implantation pattern, several reports are present in cosmopolitan species, *M. schreibersii*. In general, circulating P levels are quite low during delayed implantation and not significantly different from those of non-pregnant females. Significantly elevated P levels were observed during fetal development accompanied by development of the placenta, reaching peaks for one month prior to parturition (Martin and Bernard, 2000). A comparison of data from different populations of *M. schreibersii* in the world

may be useful (Martin and Bernard, 2000).

CONCLUSIONS AND PERSPECTIVES

Bats are highly successful mammals, second to rodents in the number of individuals and the diversity of species. Their reproductive pattern, the timing and duration also vary considerably among species and different habitats. The annual changes in the hypothalamo-adenohypophysial-gonadal axis and other endocrine characteristics in bats have been reviewed here, based mainly on our studies in hibernating rhinolophid bats, *R. ferrumequinum*. General summary is illustrated in Fig. 8. Although knowledge has considerably been accumulated on reproductive biology in chiropterian species, precise neuroendocrine mechanism regulating the reproduction of bats remains unsolved.

The reproductive activities in wild mammalian species are influenced by environmental factors, such as photoperiod, ambient temperature, relative humidity, food availability, and so on. In bats inhabiting temperate zones, the period of torpor induced by low ambient temperature and food deprivation act to arrest or retard the progress of reproductive events (Racey, 1982). In the natural environment of the temperate zones, annual changes in photoperiod are accompanied by simultaneous changes in ambient temperature. The available food becomes poor before winter. In bats, spermatogenesis occurs in summer, the season with a long-day photoperiod, but mating takes place when daylengths become short and gonadal activity is decreased (autumn). In general, seasonal breeding mammals are classified as long-day or short-day breeders according to which daylength stimulates reproductive activity. However, nocturnal bats are difficult to categorize on this basis owing to a seasonally separated asynchrony associated with reproductive phenomena. Beasley *et al.* (1984) and Beasley and Zucker (1984) showed in microchiropteran bats, *A. pallidus* (Vespertilionidae), that exposure to a short-day photoperiod or melatonin treatment accelerated testicular regression to the autumn level, suggesting that these treatments influenced the reproductive functions by affecting the endogenous circannual reproductive rhythm. In megachiropteran bats, *P. poliocephalus* (Pteropodidae), however, several investigators showed that photoperiod is unlikely to be a major environmental factor affecting reproductive activity (McGuckin and Blackshaw, 1992; O'Brien *et al.*, 1993). Clarification of whether such contradictory results are due to species variation or the difference in habitat latitude will require further studies.

In the past decade, major advances in endocrinology have been made in determining the chemical structure of hormones and receptor genes and examining the regulation of gene expression. Despite continuing efforts, studies at the molecular level and the establishment of a homologous assay for bat adenohypophysial hormones have not been done. The lack of such investigations seems to be in part due to difficulty in rearing bats in the laboratory. According

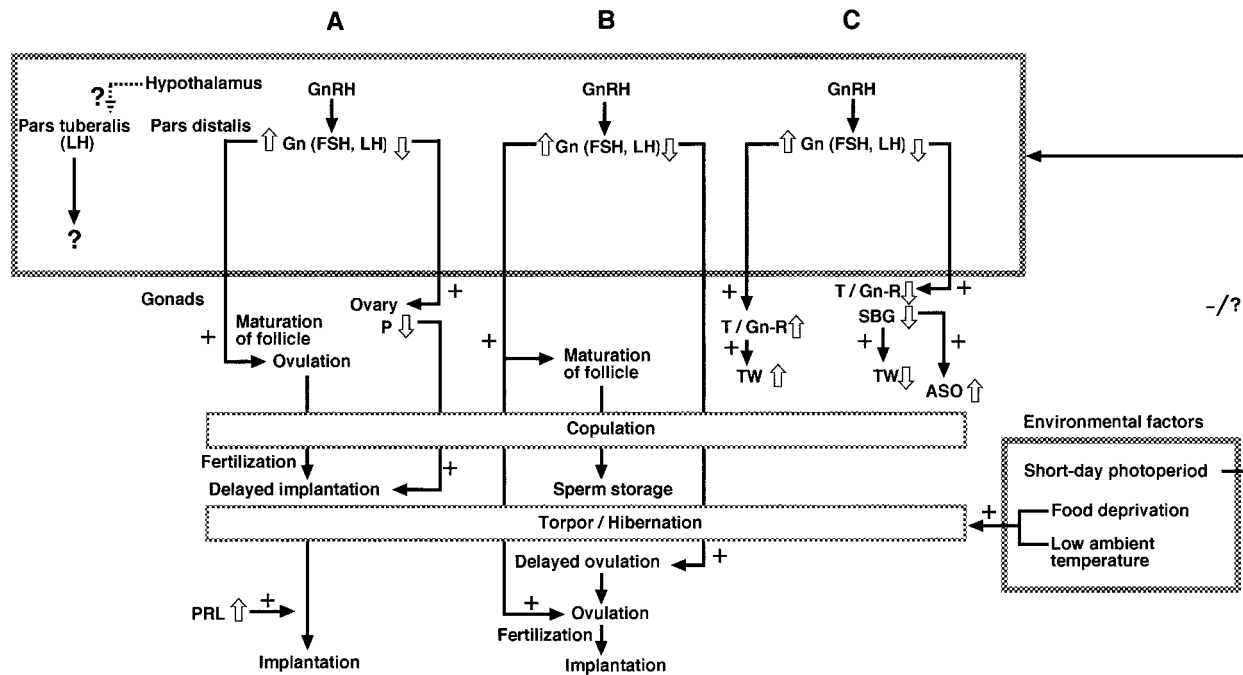

Fig. 8. Summarized endocrine characteristics and control in bats living in the temperate zone. A: female bats showing delayed implantation pattern, B: female bats showing delayed ovulation/fertilization pattern, C: male bats showing asynchronized recrudescence. ASO: accessory sex organs, Gn: gonadotropin, Gn-R: gonadotropin receptor, TW: testicular weight. \uparrow : increase, \downarrow : decrease, +: acceleration or stimulation, -: inhibition. Other abbreviations are cited in the text.

to results by other laboratories, long-term feeding in the laboratory is possible in some species of vespertilionid bats. In our preliminary trial, feeding was successful for a few species of vespertilionid bats for more than a year. Unfortunately, however, reproduction has not been successful in the laboratory except for megachiropteran bats. The lack of suitable experimental model in bats seems to be the greatest problem to be solved.

ACKNOWLEDGMENT

The author thanks Dr. Seiichiro Kawashima, Emeritus Professor of University of Tokyo and Director of Research Laboratory, Zenyaku Kogyo Co., Ltd. for his critical reading of the manuscript and helpful suggestions.

REFERENCES

- Abou-Issa H, Reichert LE Jr (1977) Solubilization and some characteristics of the follitropin receptor from calf testis. *J Biol Chem* 252: 4166–4174
- Aguado LI, Hancke JL, Rodriguez S, Rodriguez EM (1982) Changes in the luteinizing hormone content of the rat pars tuberalis during the estrus cycle and after lesions in the preoptic area. *Neuroendocrinology* 35: 178–185
- Altringham JD (1996) *Bats: Biology and Behavior*. Oxford University Press, Oxford
- Anthony ELP (1987) The role of the anterior pituitary and the hypothalamus in controlling reproductive cycles in bats. In "Recent Advances in the Study of Bats" Ed by MB Fenton, P Racey, JMV Rayner, Cambridge University Press, Cambridge, pp 421–439
- Anthony ELP (2000) Endocrinology of reproduction in bats: central control. In "Reproductive Biology of Bats" Ed by EG Crichton, PH Krutzsch, Academic Press, London, pp 1–26
- Anthony ELP, Bruhn TO, Weston PJ (1991) Immunocytochemical localization of growth hormone and growth hormone-releasing hormone immunoreactivity in the brain and pituitary of the little brown bat. *Am J Anat* 190: 1–9
- Anthony ELP, Gustafson AW (1984a) Seasonal variations in pituitary LH-gonadotropes of the hibernating bat *Myotis lucifugus lucifugus*: an immunohistochemical study. *Am J Anat* 170: 101–115
- Anthony ELP, Gustafson AW (1984b) Seasonal variations in pituitary thyrotropes of the hibernating bat *Myotis lucifugus lucifugus*: an immunohistochemical study. *Anat Rec* 209: 363–372
- Anthony ELP, King JC, Stopa EG (1984) Immunocytochemical localization of LHRH in the median eminence, infundibular stalk, and neurohypophysis. Evidence for multiple sites of releasing hormone secretion in humans and other mammals. *Cell Tissue Res* 236: 5–14
- Anthony ELP, Weston PJ, Montvillo JA, Bruhn TO, Neel K, King JC (1989) Dynamic aspects of the LHRH system associated with ovulation in the little brown bat (*Myotis lucifugus*). *J Reprod Fert* 87: 671–686
- Anthony ELP, Wu P, Bruhn TO, Jackson IMD (1987) Characterization of LH-RH immunoreactivity in mammalian pituitary neural lobe by HPLC. *Brain Res* 424: 258–263
- Arita J (1993) Analysis of the secretion from single anterior pituitary cells by cell immunoblot assay. *Endocrine* 19: 1–15
- Barenton B, Pelletier J (1983) Seasonal changes in testicular gonadotropin receptors and steroid content in the ram. *Endocrinology* 112: 1441–1446
- Beasley LJ, Smale L, Smith ER (1984) Melatonin influences the reproductive physiology of male pallid bats. *Biol Reprod* 30: 300–305
- Beasley LJ, Zucker I (1984) Photoperiod influences the annual

- reproductive cycle of the male pallid bat (*Antrozous pallidus*). J Reprod Fertil 70: 567–573
- Bernard RTF (1986) Seasonal changes in plasma testosterone concentrations and Leydig cell and accessory gland activity in the Cape horseshoe bat (*Rhinolophus capensis*). J Reprod Fertil 78: 413–422
- Bernard RTF, Bojarski C (1994) Effects of prolactin and hCG treatment on luteal activity and the conceptus during delayed implantation in Schreibers' long-fingered bat (*Miniopterus schreibersii*). J Reprod Fertil 100: 359–365
- Bernard RTF, Bojarski C, Millar RP (1991a) Patterns of Leydig cell and LH gonadotroph activity, and plasma testosterone concentrations in the seasonally reproducing Schreibers' long-fingered bat (*Miniopterus schreibersii*). J Reprod Fertil 91: 479–492
- Bernard RTF, Bojarski C, Millar RP (1991b) Plasma progesterone and luteinizing hormone concentrations and the role of the corpus luteum and LH gonadotrophs in the control of delayed implantation in Schreibers' long-fingered bat (*Miniopterus schreibersii*). J Reprod Fertil 93: 31–42
- Berkowitz AS, Heindel JJ (1984) Testicular recrudescence in the golden hamster (*Mesocricetus auratus*): a possible model for sexual maturation. Endocrinology 114: 855–860
- Buchanan GD, Younglai EV (1986) Plasma progesterone levels during pregnancy in the little brown bat *Myotis lucifugus* (Vespertilionidae). Biol Reprod 34: 878–884
- Buchanan GD, Younglai EV (1988) Plasma progesterone concentrations in the little brown bat (*Myotis lucifugus*) during hibernation. J Reprod Fertil 83: 59–65
- Calvo JC, Sagripanti JL, Peltzer LE, Guzman JA, Charreau EH (1986) Photoperiod, follicle-stimulating hormone receptors, and testicular function in vizcachas (*Lagostomus maximus maximus*). Biol Reprod 35: 822–827
- Chafuen S, Cannata MA (1979) The adenohipophysial hormone content of the pars tuberalis. Experientia 35: 1404–1405
- Clarke JR (1981) Physiological problems of seasonal breeding in eutherian mammals. Oxford Rev Reprod Biol 3: 244–312
- Closset J, Maughin-Rogister G, Ketelslegers JM, Hennen G (1977) Characterization of a soluble follitropin receptor from porcine testis. Biochem Biophys Res Commun 79: 372–379
- Conn PM (1994) The molecular mechanism of gonadotropin-releasing hormone action in the pituitary. In "The Physiology of Reproduction 2nd edition" Ed by E Knobil, JD Neil, Raven Press, New York, pp 1825–1832
- Fernández AM, Muñoz E, Gragera RR, Martínez-Rodríguez R (1992) Immunocytochemical localization of GnRH in the hypothalamus of the bat, *Miniopterus schreibersii schreibersii*. J Hirnforsch 33: 195–202
- Fleming TH (1971) *Artibeus jamaicensis*: delayed embryonic development in a neotropical bat. Science 171: 402–404
- Gharib SD, Wierman ME, Shupnik MA, Chin WW (1990) Molecular biology of the pituitary gonadotropins. Endocr Rev 1: 177–199
- Glass JD (1986) Short photoperiod-induced gonadal regression: effects on the gonadotropin-releasing hormone (GnRH) neuronal system of the white-footed mouse, *Peromyscus leucopus*. Biol Reprod 35: 733–743
- Golman BD, Darrow JM (1983) The pineal gland and mammalian photoperiodism. Neuroendocrinology 37: 386–396
- Guerra M, Rodriguez EM (2001) Identification, cellular and subcellular distribution of 21 and 72 kDa protein (tuberalin?) secreted by specific cells of the pars tuberalis. J Endocrinol 168: 363–379
- Gustafson AW (1979) Male reproductive patterns in hibernating bats. J Reprod Fertil 56: 317–331
- Gustafson AW, Damassa DA (1984) Perinatal and postnatal patterns of plasma sex steroid-binding protein and testosterone in relation to puberty in the male little brown bat. Endocrinology 115: 2347–2354
- Gustafson AW, Damassa DA (1985) Annual variations in plasma sex steroid-binding protein and testosterone concentrations in the adult male little brown bat: relation to the asynchronous recrudescence of the testis and accessory reproductive organs. Biol Reprod 33: 1126–1137
- Hayashi T, Uchida K, Kawamoto K (2002) Basic properties and annual changes of follicle-stimulating hormone receptors in the testis of horseshoe bats, *Rhinolophus ferrumequinum*. J Exp Zool 292: 304–313
- Hazlerigg DG (2001) What is the role of melatonin within the anterior pituitary? J Endocrinol 170: 493–501
- Hazlerigg DG, Morgan PJ, Messenger S (2001) Decoding photoperiodic time and melatonin in mammals: what can we learn from the pars tuberalis? J Biol Rhythms 16: 326–335
- Heideman, PD (1989) Delayed development in Fischer's pygmy fruit bat, *Haplonycteris fischeri*, in the Philippines. J Reprod Fertil 85: 363–382
- Hosken DJ, O'Shea JE, Blackberry M (1996) Blood plasma progesterone levels, sperm storage and sperm viability in Gould's Wattleed Bat (*Chalinolobus gouldii*) (Chiroptera: Vespertilionidae). J Reprod Fertil 108: 171–177
- Howell-Skalla L, Bunick D, Bleck G, Nelson RA, Bahr JM (2000) Cloning and sequence analysis of the extracellular region of the polar bear (*Ursus maritimus*) luteinizing hormone receptor (LHR), follicle stimulating receptor (FSHR), and prolactin receptor (PRLr) genes and their expression in the testis of the black bear (*Ursus americanus*). Mol Reprod Dev 55: 136–145
- Hozumi H, Kawamoto K (2001) Photoperiodic regulation on expression of gonadotropin mRNA in the adenohipophysis of hamsters. Zool Sci 18 (Suppl): 5
- Ishibashi T, Shiino M (1989) Subcellular localization of prolactin in the anterior pituitary cells of the female Japanese house bat, *Pipistrellus abramus*. Endocrinology 124: 1056–1063
- Jemenez L, Muñoz E, Ruá C (1987) Immunocytochemical study of prolactin cells during gestation and lactation in the *Myotis myotis*. Zeitsch Mikro-Anat Forsch 101: 649–652
- Jennes L, Stumpf WE (1980) LHRH systems in the brain of the golden hamster. Cell Tissue Res 209: 239–256
- Kawakami S, Winters SJ (1999) Regulation of luteinizing hormone secretion and subunit messenger ribonucleic acid expression by gonadal steroids in perfused pituitary cells from male monkeys and rats. Endocrinology 140: 3587–3593
- Kawamoto K, Kurahashi S, Hayashi T (1998) Changes in the gonadotropin-releasing hormone (GnRH) neuronal system during the annual reproductive cycle of the horseshoe bat, *Rhinolophus ferrumequinum*. Zool Sci 15: 779–786
- Kawamoto K, Tanaka S, Fujimori N (1999) Short photoperiod increases the functional state of gonadotrophs in the pars tuberalis of hamsters. Zool Sci 16 (Suppl): 19
- Kawamoto K, Tanaka S, Hayashi T (2000a) Secretory activity of gonadotropin and the responsiveness of gonadotrophs to gonadotropin-releasing hormone during the annual reproductive cycle of male bats, *Rhinolophus ferrumequinum*: analysis by cell immunoblot assay. J Exp Zool 287: 213–224
- Kawamoto K, Tanaka S, Kawano M, Hayashi T, Tsuchiya K (2000b) Effects of photoperiod and ambient temperature on the gonadotropin-releasing hormone neuronal system in the gray hamster, *Tscherskia triton*. Neuroendocrinology 72: 284–292
- Kineman RD, Faught WJ, Frawley S (1991) Mammosomatotropes are abundant in bovine pituitaries: influence of gonadal status. Endocrinology 128: 2229–2233
- King JA, Steneveld AA, Curlew JD, Rissman EF, Millar RP (1994) Identification of chicken GnRH II in brains of metatherian and early-evolved eutherian species of mammals. Regul Peptides 54: 467–477
- King JC, Anthony ELP, Gustafson AW, Damassa DA (1984) Luteinizing hormone-releasing hormone (LH-RH) cells and their pro-

- jections in the forebrain of the bat *Myotis lucifugus lucifugus*. *Brain Res* 298: 289–301
- Kriegsfeld LJ, Nelson RJ (1999) Photoperiod affects the gonadotropin-releasing hormone neuronal system of male prairie voles (*Microtus ochrogaster*). *Neuroendocrinology* 69: 238–244
- Li J, Stefanescu L, Kovacs K, Horvath E, Smyth H (1993) Growth hormone (GH) and prolactin (PRL) gene expression and immunoreactivity in GH- and PRL-producing human pituitary adenomas. *Virchows Archiv A Pathol Anat* 422: 193–201
- Lloyd RV, Meares JD, Jacobi J (1975) Effects of oestrogen and bromocryptine on *in vivo* secretion and mitosis in prolactin cells. *Nature* 255: 497–498
- Malpoux B, Migaud M, Tricoire H, Chemineau P (2001) Biology of mammalian photoperiodism and the critical role of the pineal gland and melatonin. *J Biol Rhythms* 16: 336–347
- Marshall JC, Dalkin AC, Haisenleder DJ, Paul SJ, Ortolano GA, Kelch RP (1991) Gonadotropin-releasing hormone pulses: regulators of gonadotropin synthesis and ovulatory cycles. *Recent Prog Horm Res* 47: 155–187
- Martin L, Bernard RTF (2000) Endocrine regulation of reproduction in bats: the role of circulating gonadal hormones. In "Reproductive Biology of Bats" Ed by EG Crichton, PH Krutzsch, Academic Press, London, pp 27–64
- McCracken GF, Wilkinson GS (2000) Bat mating systems. In "Reproductive Biology of Bats" Ed by EG Crichton, PH Krutzsch, Academic Press, London, pp 321–362
- McGuckin MA, Blackshaw AW (1991a) Seasonal changes in testicular size, plasma testosterone concentration and body weight in captive flying foxes (*Pteropus poliocephalus* and *P. scapulatus*). *J Reprod Fertil* 92: 339–346
- McGuckin MA, Blackshaw AW (1991b) Mating-associated peak in plasma testosterone concentration in wild male grey-headed flying foxes (*Pteropus poliocephalus*). *J Reprod Fertil* 92: 347–352
- McGuckin MA, Blackshaw AW (1992) Effects of photoperiod on the reproductive physiology of male flying foxes, *Pteropus poliocephalus*. *Reprod Fertil Dev* 4: 43–53
- Mikami S, Chiba S, Hojo H, Taniguchi K, Kubokawa K, Ishii S (1988a) Immunocytochemical studies on the pituitary pars distalis of the Japanese long-fingered bat, *Miniopterus schreibersii fuliginosus*. *Cell Tissue Res* 251: 291–299
- Mikami S, Chiba S, Taniguchi K, Kubokawa K, Ishii S (1988b) Immunocytochemical localization of neuropeptides in the hypothalamus of the Japanese long-fingered bat, *Miniopterus schreibersii fuliginosus*. *Cell Tissue Res* 254: 49–57
- Milette JJ, Schwartz NB, Turek FW (1988) The importance of follicle-stimulating hormone in the initiation of testicular growth in photostimulated Djungarian hamsters. *Endocrinology* 122: 1060–1066
- Mulchahey JJ, Jaffe RB (1988) Detection of a potential progenitor cell in the human fetal pituitary that secretes both growth hormone and prolactin. *J Clin Endocr Metab* 66: 24–32
- Muñiz E, Jimenez L, Gragera R, Fernández A, Rua C (1991) Ultrastructural changes in the gonadotrophic and prolactin cells of *Myotis myotis* under experimental conditions. *Funct Dev Morph* 1: 15–18
- Nikitovitch-Winer MB, Atkin J, Maley BE (1987) Colocalization of prolactin and growth hormone within specific adenohypophysial cells in male, female, and lactating female rats. *Endocrinology* 121: 625–630
- Niklowitz P, Khan S, Bergman M, Hoffmann K, Nieschlag E (1989) Differential effects of follicle-stimulating hormone and luteinizing hormone on Leydig cell function and restoration of spermatogenesis in hypophysectomized and photoinhibited Djungarian hamsters (*Phodopus sungorus*). *Biol Reprod* 41: 871–880
- Nurnberger F (1995) The neuroendocrine system in hibernating mammals: present knowledge and open questions. *Cell Tissue Res* 281: 391–412
- O'Brien GM, Curlew JD, Martin L (1993) Effect of photoperiod on the annual cycle of testis growth in a tropical mammal, the little red flying fox, *Pteropus scapulatus*. *J Reprod Fertil* 98: 121–127
- O'Brien GM, Curlew JD, Martin L (1996) A heterologous assay for measuring prolactin in pituitary extracts and plasma from Australian flying foxes (genus *Pteropus*). *Gen Com Endocrinol* 104: 304–311
- Oelschlager HA, Northcutt RG (1992) Immunocytochemical localization of luteinizing hormone-releasing hormone (LHRH) in the nervus terminalis and brain of the big brown bat, *Eptesicus fuscus*. *J Comp Neurol* 315: 344–363
- Oxberry BA (1979) Female reproductive patterns in hibernating bats. *J Reprod Fertil* 56: 359–367
- Parker CR, Neaves WB, Porter JC (1980) Regional and subcellular localization of LHRH in adult human brain. *Brain Res Bull* 5: 307–313
- Pickard GE, Silverman AJ (1979) Effects of photoperiod on hypothalamic luteinizing hormone releasing hormone in the male hamster. *J Endocr* 83: 421–428
- Pieper DR (1984) Effects of photoperiod, castration and gonadotropin-releasing hormone (GnRH) on the number of GnRH receptors in male golden hamsters. *Endocrinology* 115: 1857–1862
- Racey PA (1982) Ecology of bat reproduction. In "Ecology of Bats" Ed by TH Kunz, Plenum Press, New York, pp 57–104
- Racey PA, Entwistle AC (2000) Life-history and reproductive strategies of bats. In "Reproductive Biology of Bats" Ed by EG Crichton, PH Krutzsch, Academic Press, London, pp 363–414
- Richardson BA (1979) The anterior pituitary and reproduction in bats. *J Reprod Fertil* 56: 379–389
- Richardson BA (1981a) Localization of gonadotrophic hormones in the pituitary gland of the California leaf-nosed bat (*Macrotus californicus*). *Cell Tissue Res* 220: 115–123
- Richardson BA (1981b) Identification of prolactin and growth hormone cells in the pars distalis of the California leaf-nosed bat, *Macrotus californicus*. *Am J Anat* 161: 427–440
- Schlatt S, De Geyter M, Kliesch S, Nieschlag E, Bergmann M (1995) Spontaneous recrudescence of spermatogenesis in the photoinhibited male Djungarian hamster, *Phodopus sungorus*. *Biol Reprod* 53: 1169–1177
- Silverman AJ, Krey LC, Zimmerman EA (1979) A comparative study of the luteinizing hormone releasing hormone (LHRH) neuronal networks in mammals. *Biol Reprod* 20: 98–110
- Silverman AJ, Antunes JL, Abrams GM, Nilaver G, Thau R, Robinson JA, Ferin M, Krey LC (1982) The luteinizing hormone-releasing hormone pathway in rhesus (*Macaca mulatta*) and pigtailed (*Macaca nemestrina*) monkeys: new observations on thick, unembedded sections. *J Comp Neurol* 211: 309–317
- Simoni M, Gromoll J, Nieschlag E (1997) The follicle-stimulating hormone receptor: biochemistry, molecular biology, physiology, and pathophysiology. *Endocr Rev* 18: 739–773
- Simpson SM, Follett BK, Ellis DH (1982) Modulation by photoperiod of gonadotrophin secretion in intact and castrated Djungarian hamsters. *J Reprod Fert* 66: 243–250
- Singh UP, Krishna A (1996a) Immunocytochemical studies on the pituitary pars distalis of the tropical vespertilionid bat, *Scotophilus heathi*, with reference to the ovarian cycle. *Acta Anat* 155: 104–112
- Singh UP, Krishna A (1996b) Pituitary adrenocorticotrophic (ACTH) cells during reproductive cycle in a Vespertilionid bats, *Scotophilus heathi*. *Acta Biol Hung* 48: 409–420
- Sinha Hikim AP, Bartke A and Russell LD (1988) Morphometric studies on hamster testes in gonadally active and inactive states: light microscope findings. *Biol Reprod* 39: 1225–1237
- Smith PF, Luque EH, Neill JD (1986) Detection and measurement

- of secretion from individual neuroendocrine cells using a reverse hemolytic plaque assay. *Methods Enzymol* 124: 443–465
- Steinberger A, Steinberger E (1977) Replication patterns of Sertoli cells in maturing rat testis *in vivo* and in organ culture. *Biol Reprod* 4: 84–87
- Stirland JA, Johnston JD, Cagampang FRA, Morgan PJ, Castro MG, White MRH, Davis JRE, Loudon ASI (2001) Photoperiodic regulation of prolactin gene expression in the Syrian hamster by a pars tuberalis-derived factor. *J Neuroendocr* 13: 147–157
- Takahashi S (1995) Development and heterogeneity of prolactin cells. *Int Rev Cytol* 157: 33–98
- Tamarkin L, Hutchison JS, Goldman BD (1976) Regulation of serum gonadotropins by photoperiod and testicular hormone in the Syrian hamster. *Endocrinology* 99: 1528–1533
- Thanki KH, Steinberger A (1978) Effect of age and hypophysectomy on FSH binding by rat testes. *Andrologia* 10: 195–202
- Tsutsui K, Kawashima S, Masuda A, Oishi T (1988) Effects of photoperiod and temperature on the binding of follicle-stimulating hormone (FSH) to testicular preparations and plasma FSH concentration in the Djungarian hamster, *Phodopus sungorus*. *Endocrinology* 122: 1094–1102
- Tsutsui K, Kawashima S, Kumar V, Kapania R, Saxena RN (1989) Properties of follicle-stimulating hormone receptors and changes during annual breeding cycle in the testis of short-tailed bandicoot rat, *Nesokia india*. *Gen Comp Endocrinol* 73: 442–451
- Tsutsui K, Shimizu A, Kawamoto K, Kawashima S (1985) Developmental changes in the binding of follicle-stimulating hormone (FSH) to testicular preparations of mice and the effects of hypophysectomy and administration of FSH on the binding. *Endocrinology* 117: 2534–2543
- Turek FW, Elliott JA, Alvis JD, Menaker M (1975) The interaction of castration and photoperiod in the regulation of hypophyseal and serum gonadotropin levels in male golden hamsters. *Endocrinology* 96: 854–860
- Turzillo AM, Nolan TE, Nett TM (1998) Regulation of gonadotropin-releasing hormone (GnRH) receptor gene expression in sheep: interaction of GnRH and estradiol. *Endocrinology* 139: 4890–4894
- Uchida TA and Mōri T (1987) Prolonged storage of spermatozoa in hibernating bats. In “Recent Advances in the Study of Bats” Ed by MB Fenton, P Racey JMV Rayner, Cambridge University Press, Cambridge pp 351–366
- Vanecek J (1998) Cellular mechanisms of melatonin action. *Physiol Rev* 78: 687–721
- Witkin JW, Paden CM, Silverman AJ (1982) The luteinizing hormone-releasing hormone (LHRH) systems in rat brain. *Neuroendocrinology* 35: 429–438
- Wittkowski W, Bockmann J, Kreutz MR, Böckers TM (1999) Cell and molecular biology of the pars tuberalis of the pituitary. *Int Rev Cytol* 185: 157–194
- Yellon SM, Goldman BD (1987) Influence of short days on diurnal patterns of serum gonadotrophins and prolactin concentrations in the male Djungarian hamster, *Phodopus sungorus*. *J Reprod Fert* 80: 167–174

(Accepted June 23, 2003 / Invited Review)