



## **SKELETAL AND DENTAL ANATOMY OF LAMNIFORM SHARK, CRETALAMNA APPENDICULATA, FROM UPPER CRETACEOUS NIOBRARA CHALK OF KANSAS**

Author: Shimada, Kenshu

Source: Journal of Vertebrate Paleontology, 27(3) : 584-602

Published By: The Society of Vertebrate Paleontology

URL: [https://doi.org/10.1671/0272-4634\(2007\)27\[584:SADAOL\]2.0.CO;2](https://doi.org/10.1671/0272-4634(2007)27[584:SADAOL]2.0.CO;2)

---

BioOne Complete ([complete.BioOne.org](https://complete.BioOne.org)) is a full-text database of 200 subscribed and open-access titles in the biological, ecological, and environmental sciences published by nonprofit societies, associations, museums, institutions, and presses.

Your use of this PDF, the BioOne Complete website, and all posted and associated content indicates your acceptance of BioOne's Terms of Use, available at [www.bioone.org/terms-of-use](https://www.bioone.org/terms-of-use).

Usage of BioOne Complete content is strictly limited to personal, educational, and non - commercial use. Commercial inquiries or rights and permissions requests should be directed to the individual publisher as copyright holder.

---

BioOne sees sustainable scholarly publishing as an inherently collaborative enterprise connecting authors, nonprofit publishers, academic institutions, research libraries, and research funders in the common goal of maximizing access to critical research.

## SKELETAL AND DENTAL ANATOMY OF LAMNIFORM SHARK, *CRETALAMNA APPENDICULATA*, FROM UPPER CRETACEOUS NIOBRARA CHALK OF KANSAS

KENSHU SHIMADA

Environmental Science Program and Department of Biological Sciences, DePaul University, 2325 North Clifton Avenue, Chicago, Illinois 60614, U.S.A.; and Sternberg Museum of Natural History, Fort Hays State University, Hays, Kansas 67601, U.S.A., kshimada@depaul.edu

**ABSTRACT**—*Cretalamna* (= *Cretolamna*) *appendiculata* is an extinct lamniform shark primarily known by isolated teeth and traditionally classified into Cretoxyrhinidae. Here, a partial skeleton of *C. appendiculata* from the Upper Cretaceous Niobrara Chalk of Kansas is described. The reconstructed dentition partially corroborated with some articulated teeth on an upper jaw indicates that the shark had a lamnoid tooth pattern. Adjacent teeth apparently abutted each other without overlap and the dentition likely had a cutting function. The reconstruction presented here differs from previously published reconstructed dentitions of *C. appendiculata* based on isolated teeth or purely disarticulated tooth sets. The overall dental pattern of *C. appendiculata* is found to be more similar to the pattern of extant *Lamna* spp. than to that of a cretoxyrhinid, *Cretoxyrhina mantelli*, possibly indicating that *Cretalamna appendiculata* may not belong to Cretoxyrhinidae. The estimated jaw lengths indicate an upper jaw overbite, which concomitantly implies a subterminal mouth in the shark. The jaw morphology indicates the presence of large dorsal and ventral quadratomandibularis muscles. The vertebrae of *C. appendiculata* are confirmed to be of lamnoid type, reaffirming *C. appendiculata* to be a lamniform. *Cretalamna appendiculata* probably had a fusiform body with a caudal fin not as elongate as in modern alopiids. The *C. appendiculata* individual likely measured at least 2.3 m and possibly as large as 3 m in total length. The extant phylogenetic bracket approach indicates that *C. appendiculata* possessed a dental bulla in each jaw. *Cretalamna appendiculata* was probably an ecological generalist.

### INTRODUCTION

Sharks (Chondrichthyes: Elasmobranchii) are fishes with poorly mineralized cartilaginous skeletons that are rarely fossilized. Therefore, most extinct sharks are known only by their hard teeth. Some exceptions are known (e.g., Maisey, 1983; Maisey and Carvalho, 1997; Shimada, 1997b; Kriwet and Klug, 2004; Shimada and Cicimurri, 2005), but much of the paleobiological inferences about extinct sharks are based on size and morphology of their teeth. *Cretalamna* (= *Cretolamna*) *appendiculata* (Agassiz, 1835) is an extinct lamniform shark that is known from Early Cretaceous–Paleocene marine rocks nearly worldwide (e.g., Cappetta, 1987; Siverson, 1992, 1996; Antunes and Cappetta, 2002). Like most other extinct sharks, the species is known primarily from isolated teeth. Applegate (1970) reported a fragmentary skeleton (consisting of 50 vertebrae and 13 teeth) of this taxon from the Upper Cretaceous Mooreville Chalk of Alabama, but very little is known about the paleobiology of the shark.

Here, I report a partial skeleton of *Cretalamna appendiculata* (Fig. 1) from the Upper Cretaceous Niobrara Chalk of western Kansas. It is housed in the Natural History Museum of Los Angeles County (LACM), California. Although the specimen is a partial skeletal remain, it represents the most well-preserved specimen of the species thus far known providing new anatomical information. In this paper, I describe the skeletal anatomy of the shark, reconstruct its dentition, and discuss the biological implications of various aspects of the observed anatomy.

### SYSTEMATIC PALEONTOLOGY

Class CHONDRICHTHYES Huxley, 1880  
Subclass ELASMOBRANCHII Bonaparte, 1838

Cohort EUSELACHII Hay, 1902  
Subcohort NEOSELACHII Compagno, 1977  
Superorder GALEOMORPHII Compagno, 1973  
Order LAMNIFORMES Berg, 1958  
Family CRETOXYRHINIDAE (?) Glickman, 1958  
Genus *CRETALAMNA* Glickman, 1958  
*CRETALAMNA APPENDICULATA* (Agassiz, 1835)  
(Figs. 1–4, 6–10)

**Material**—LACM 128126, a partial skeleton consisting of partial palatoquadrates and Meckel's cartilages, a series of 35 well-calcified vertebrae, and approximately 120 teeth that are mostly disarticulated. Placoid scales were searched but were not found.

**Locality**—Logan County, Kansas (detailed locality data are on file at LACM).

**Horizon**—The Smoky Hill Chalk Member of the Niobrara Chalk. At the locality, the upper part of the stratigraphic member is exposed and lithostratigraphically ranges up to about Hattin's (1982) Marker Unit 16 and appears to represent the late Santonian – earliest Campanian chronostratigraphically. The catalogue card of the specimen gives 'Campanian' as its age, indicating that it came from the lowermost Campanian portion of the Smoky Hill Chalk.

**Taxonomic Notes**—The genus of this species has been referred almost universally to *Cretolamna* since the late 1950s (for synonymy list, see Shimada, Schumacher et al., 2006). However, as pointed out by Siverson (1999), Glickman's (1958) original spelling of the taxon was *Cretalamna*. Therefore, the taxon is referred to *Cretalamna* here according to the International Code of Zoological Nomenclature (Articles 32 and 33: Ride et al., 1999).

Siverson (1999) discussed that the family Cretoxyrhinidae has been used as a waste basket taxon for a number of Cretaceous

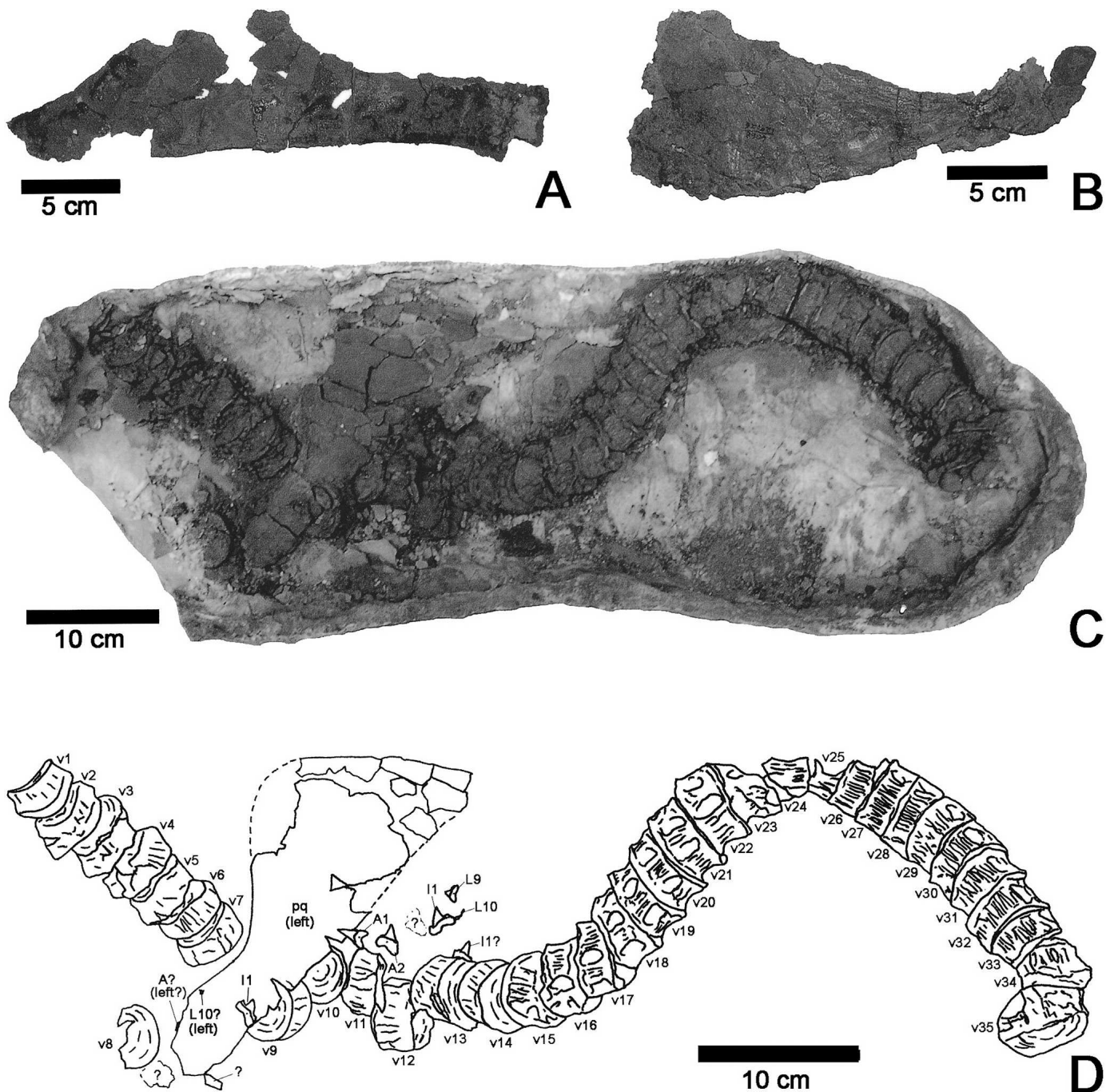

FIGURE 1. Partial skeleton of *Cretalamna appendiculata* (LACM 128126) from Niobrara Chalk of western Kansas. **A**, nearly complete right palatoquadrate (labial view; anterior to the right); **B**, pair of partial Meckel's cartilages (labial view; anterior to the right); **C**, series of 35 vertebrae with left palatoquadrate (labial view) and several disarticulated teeth (anterior to the left); **D**, line drawing of parts seen in Figure 1C. Abbreviations: A, upper anterior tooth; L, upper lateral tooth; l, lower lateral tooth; pq, palatoquadrate; v, vertebra.

and Paleogene lamniforms. He recommended that the taxon Cretoxyrhinidae should be restricted to the type genus *Cretoxyrhina* but did not accommodate the familial placements for most other lamniform genera traditionally classified into Cretoxyrhinidae. Whereas Siverson (1999) did not discuss the familial placement for *Cretalamna* in the text, he did illustrate (fig. 4) several teeth of a *Cretalamna* taxon with a caption indicating that it belongs to Otodontidae Glickman, 1964. A revision on cretoxyrhinid taxonomy, including the exact taxonomic position of

*Cretalamna*, is clearly in need, but until then, *Cretalamna* should be kept under Cretoxyrhinidae in order to minimize confusions.

#### ANATOMICAL DESCRIPTION

##### Palatoquadrate

The palatoquadrate is well preserved in LACM 128126, although the right one (Fig. 1A) is more complete than the left one

(Fig. 1C, D), and although their mesial and distal ends are missing. Both lingual and labial sides are observable on the right one, whereas only the labial side can be seen on the left one because the lingual side is adhered to the vertebral column and plaster jacket. The ventral rim is straight except toward the mesial end which forms a gentle concavity. If complete, the maximum mesiodistal length of each palatoquadrate is estimated to be about 30 cm. The mesiodistal length of the palatine process is approximately equal to that of the quadrate process (Fig. 2). The maximum dorsoventral height of the palatine process is located toward the symphysis measuring slightly over 4.5 cm, and its minimum height is situated near the quadrate process measuring about 3.5 cm. The quadrate process is dorsally expanded near its anterior end that measures about 10 cm in estimated maximum dorsoventral height, and gradually tapers off towards the posterior end. Although the dental bulla (Compagno, 1990; Siverson [1999] referred its inner side as 'anterior hollow') is inferred to be present at the mesial end of each palatoquadrate (Shimada, 2002a; see below), it is not clear in the specimen. However, a trough (= 'lateroposterior hollow' of Siverson, 1999) is present along the ventral half of the lingual surface (Fig. 2) that originally housed replacement tooth series. The trough is dorsoventrally wide (3 cm) near the symphysis and gradually tapers off as it continues distally for at least 20 cm. The dorsal trough margin exhibits as many as 15 dorsally directed, closely spaced indentations (Fig. 2), representing the extent of juxtaposed tooth rows. Nine undeveloped teeth are also found along the dorsal trough margin (Fig. 2). Other areas of the palatoquadrate, including the labial side (Fig. 1A), are flat and featureless.

### Meckel's Cartilage

Both Meckel's cartilages are incomplete in LACM 128126, where the right one (Fig. 1B) is fragmentary and appears to be adhered against the labial side of the left one. The left Meckel's cartilage (Fig. 2) measures 23 cm in preserved mesiodistal length, and was perhaps about 24 cm if complete. It is cleaver-shaped with a concaved dorsal edge and a gently convex ventral edge. The dorsoventral height of the cartilage as preserved measures from about 3 cm to 9 cm distally. The jaw surfaces are largely flat and featureless. Because the lingual surface is not observable in both sides, the presence of the dental bulla cannot be confirmed, but it was likely present (see below). No lower replacement teeth are recognized in situ.

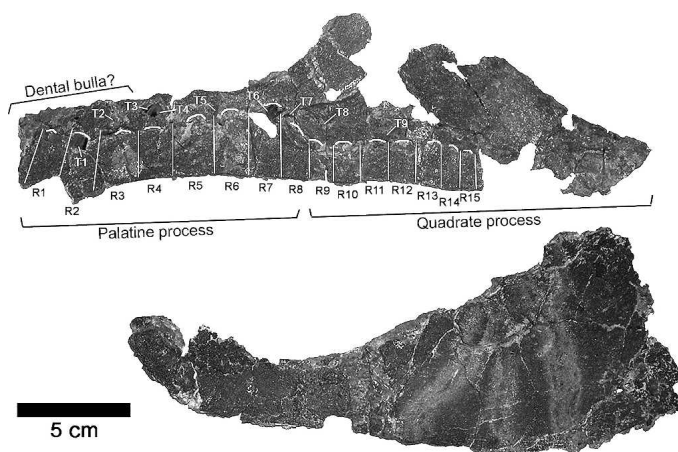

FIGURE 2. Right palatoquadrate (top; lingual view) and left Meckel's cartilage (bottom; labial view) of *Cretalamna appendiculata* (LACM 128126; anterior to the left; cf. Fig. 2A, B). Notations: R, putative tooth row; T, tooth in situ; parallel to subparallel vertical lines, putative tooth row boundaries; short white arches, dorsal rim of each putative tooth row.

### Vertebrae

The vertebral column in LACM 128126 consists of 35 anterior-most vertebral centra, measuring approximately 82 cm in preserved length along the column axis (Fig. 1C). The vertebrae are mostly articulated and referred to as 'v1' through 'v35,' counting sequentially from the anterior-most centrum in the specimen (Fig. 1D). They are well calcified and structurally described as 'lamnoid vertebrae' (sensu Applegate, 1967), exhibiting concentric lamellae around the unperforated primary double-cone amphicoelous calcification (Fig. 3; see also Applegate, 1970). The centra are asterospondylic with many tightly spaced, radiating calcified lamellae (Fig. 3D; for terminology, see Ridewood, 1921; see below for further discussion). The lamellae also include the walls of a pair of circular to oval pits for the basidorsal and basiventral cartilages (see Welton and Farish, 1993) on opposite sides along the periphery of each centrum (Fig. 3C). All centra suffer taphonomic distortion, thus offering very few meaningful measurements. The diameter of the anterior face of the first vertebra, where it attached to the occipital centrum of the skull in life, measures about 35 mm. The least distorted vertebra is v9 (Fig. 3A, B), and it measures 40 mm in diameter and 16 mm in anteroposterior length.

### Teeth (General)

Teeth in LACM 128126 exhibit considerable variation in size and shape. Total tooth heights range from 5.5 to 19.9 mm, and tooth widths from 5.5 to 20.4 mm. Some teeth are almost bilaterally symmetrical, whereas others are highly asymmetrical. Nevertheless, all fully developed teeth (e.g., Fig. 4) show a moderately thick, triangular principal cusp with a pair of broad, divergent, triangular lateral cusplets, a narrow tooth neck on the lingual side between the crown and root, a well-developed bilobed root, and osteodont tooth histology (see also Welton and Farish, 1993). The principal cusp and lateral cusplets possess a razor-like cutting edge and smooth surfaces. The bilobed root has a relatively low lingual protuberance generally with one small nutritive foramen (note: some lack the foramen whereas some have a few). Further dental descriptions are given below.

## RECONSTRUCTION OF DENTITION

### General Plan and Terminology

The dentition of *Cretalamna appendiculata* was previously reconstructed by Welton and Farish (1993) and by Applegate and Espinosa-Arrubarrena (1996) (Fig. 5A, B). Welton and Farish's (1993) reconstruction was based on a set of isolated teeth from multiple individuals. Applegate and Espinosa-Arrubarrena (1996) based their reconstruction on some previously reported associated (but disarticulated) tooth sets (e.g., Woodward, 1911; Arambourg, 1952; for additional comments, see also Siverson, 1999:59). Because both reconstructions are based on isolated and/or disarticulated teeth from more than one shark individual, they are considered artificial (sensu Shimada, 2006a) in which their accuracy remains questionable.

I use LACM 128126 to reconstruct the upper and lower dentitions of *Cretalamna appendiculata*. Because the tooth set consists largely of disarticulated teeth, the reconstruction must initially be conducted by assuming that *C. appendiculata* belongs to Lamniformes in order to allow some basis for comparisons. The tooth type is identified for each tooth, and 11 dental measurements (Fig. 4) are taken from the best preserved tooth for each tooth type (Appendix 1).

Tooth type terminology follows Shimada's (2002a) scheme

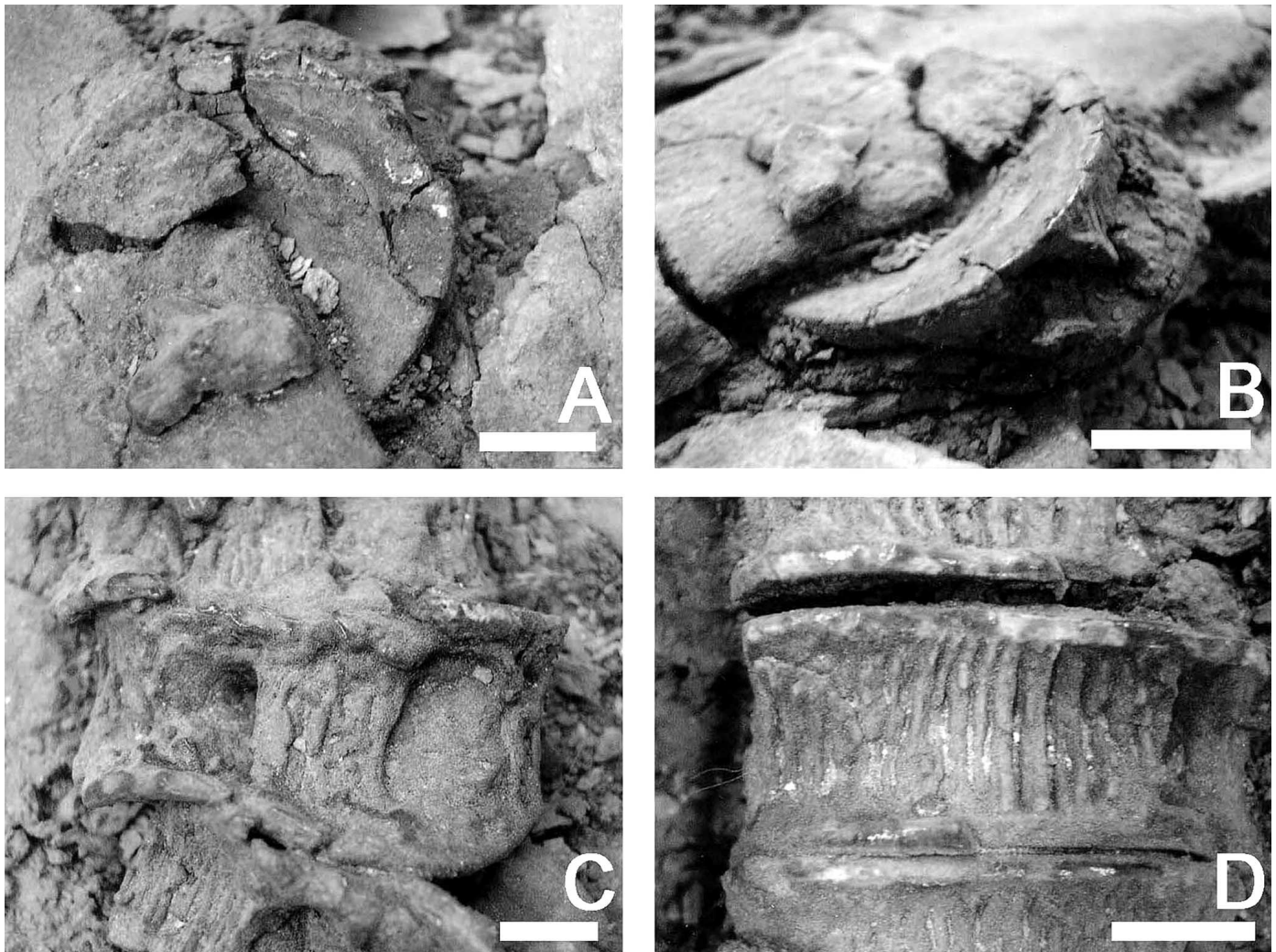

FIGURE 3. Vertebral centra of *Cretalamna appendiculata* (LACM 128126; see Fig. 1C, D). **A**, articular view of ninth vertebra (partially covered by left palatoquadrate); **B**, oblique view of ninth vertebra (cf. Fig. 3A); **C**, dorsal view of 20th vertebra; **D**, lateral view of 27th vertebra. Scale = 1 cm.

which is based on the identification of putative homologous teeth across modern macrophagous lamniforms using 1:1 topographic correspondence of occluded tooth rows and non-dental anatomical markers. Siverson and Lindgren (2005) recently questioned Shimada's (2002a) reliance on skeletonized jaws by pointing out that the tooth positions of mesially located teeth may shift based on their observation of captive sand tiger shark, *Carcharias taurus*, swimming in an aquarium. As described, Shimada's (2002a) notion of 'occlusion' in lamniforms is interlocking upper and lower tooth rows upon jaw adduction. I note here that *C. taurus* has multiple series of functional teeth in the mesially located tooth rows (i.e., symphyisial and anterior teeth), and such functional teeth may advance so labially on a curved jaw surface (by lingering long) that their occlusional relationships may not become obvious compared to functional and well-developed replacement teeth located lingually that would occlude with the opposing tooth rows. My experience with manipulating jaws of various modern lamniforms suggests that the extent of outward and inward rotations of each jaw cartilage appears to be greater in taxa with lanceolate (grasping) teeth such as *Mitsukurina* and *Carcharias* (vs. taxa with broad 'cutting type' teeth: e.g., see Shimada, 2005), but the occlusional relationships of teeth, particularly those that just became functional (erect), remain consistent because the position of symphyisial and mandibular ar-

ticulations of jaw cartilages is fixed. Jaw kinematics in modern lamniforms is an area of research clearly in need (e.g., see Motta and Wilga, 2001; Motta, 2004; Wilga, 2005). However, the use of Shimada's (2002a) tooth type terminology here is justified because the scheme rests on the only repeatable and the least subjective method for lamniform dentitions.

Shimada's (2002a) tooth type classification recognizes up to four tooth types in each upper and lower jaw quadrant in a macrophagous lamniforms that constitutes the so-called 'lamnoid tooth pattern': symphyisial, anterior, intermediate, and lateral tooth rows. On each jaw, the scheme assumes the presence of two anterior and at least one intermediate tooth rows, whereas the number of symphyisial and lateral tooth rows may vary interspecifically and intraspecifically. The scheme does not recognize the tooth type traditionally called 'posterior teeth' (e.g., Applegate, 1965), but they are assimilated into lateral tooth rows. The recognition of an intermediate tooth row in the lower dentition is a matter of convention, and one may consider it as the third lower anterior tooth row (Shimada, 2002a).

#### Reconstruction Procedures

Because of the presence of a large number of teeth in LACM 128126, the assumption is made that the tooth set includes teeth

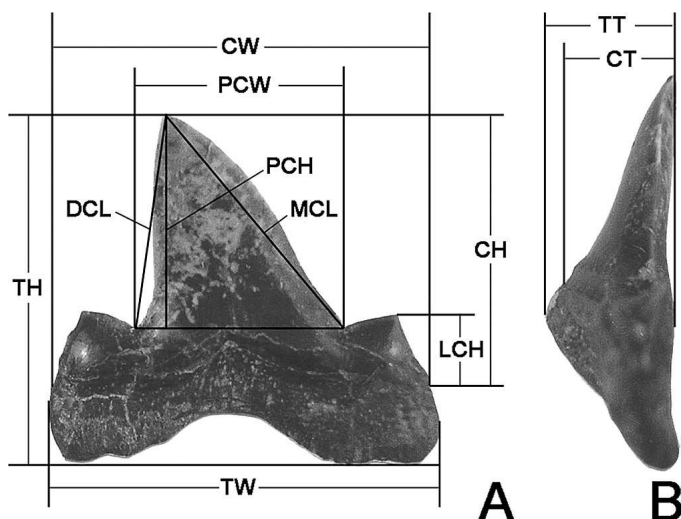

FIGURE 4. Dental measurements taken for each tooth type of *Cretalamna appendiculata* in LACM 128126 (see Appendix 1). **A**, labial view of tooth; **B**, profile (mesial) view of the same tooth. Abbreviations: TH, tooth height; TW, tooth width; TT, tooth (labiolingual) thickness; CH, crown height; CW, crown width; CT, crown (labiolingual) thickness; LCH, lateral cusplet height; PCH, principle (main) cusp height; PCW, principle (main) cusp width; MCL, mesial cutting edge length; DCL, distal cutting edge length.

from all four jaw quadrants. Heavily damaged teeth and those not fully mineralized (i.e., indicated by undeveloped root) are excluded (Fig. 6Aa). Also, teeth that are quite different in size and morphology compared to the majority of teeth are set aside (e.g., putative symphyseal teeth; Fig. 6Ab).

The inclination of principal cusp is used to divide the majority of teeth into two groups: one group consisting of upper right and lower left teeth (Fig. 6Ac), and the other group upper left and lower right teeth (Fig. 6Ad). Simultaneously, teeth in each group are organized according to their sizes and extent of cusp inclination. Teeth found to be virtually identical in size and morphology to each other are interpreted to come from the same tooth row and are thus lumped together. It should be noted that, in lamniforms, the organization of the mesial side of the dentition is more complex than that of the distal side, and the size and cusp inclination between adjacent teeth are more subtle in distally located teeth than in mesially located teeth (see Shimada, 2002a). Thus, teeth in each group are sequentially assembled from smaller, more inclined principal cusps (i.e., presumed distally located lateral teeth) to larger, more erect principal cusps (e.g., presumed anterior teeth).

For each of the two groups of teeth, subtle morphological variation indicative of differences between upper right teeth and lower left teeth (Fig. 6Ac) as well as between upper left teeth and lower right teeth (Fig. 6Ad) are detected. One of the two subgroups in each group consists of teeth with slightly mesiodistally narrower and labiolingually thicker crown compared to similar sized teeth in another subgroup. The former subgroup (Fig. 6Bd, f) is interpreted to be the lower teeth, the latter (Fig. 6Bb, e) the upper teeth according to a similar trend found in many modern lamniform teeth (e.g., Shimada, 2002a).

Some relatively large teeth (Fig. 6Ba, g) are found to be uniquely different from other 'large teeth' by exhibiting a strongly curved principal cusp. These teeth are not able to be placed into any part of the dentition except as putative intermediate teeth (see Shimada, 2002a). One unique situation with LACM 128126 is that testing whether or not they are intermediate teeth is possible, because several replacement teeth are in

situ on the right palatoquadrate (Fig. 2). The putative upper right dentition (Fig. 6Bb) and putative intermediate teeth (Fig. 6Ba, g) are compared against the teeth on the palatoquadrate (Fig. 6C). The result is that one set of putative intermediate teeth (Fig. 6Ba) is found to be in fact from the row of upper right intermediate teeth, whereas the other set is determined to belong to the left dentition. Furthermore, despite of some necessary minor adjustments (e.g., one of the putative lower anterior teeth re-identified as an upper anterior tooth: i.e., right-most tooth in Figure 6Bd), much of the initial arrangement of upper right teeth (Fig. 6Bb) is found to be consistent with the dental pattern seen in situ on the palatoquadrate (Fig. 6C).

One last unresolved problem is to determine as to which jaw quadrant the two putative symphyseal teeth originated. Shimada (1997a, 2002a) reported the dentition of a Cretaceous cretoxyrhinid shark, *Cretoxyrhina mantelli* (Fig. 5D), and the two *Cretalamna* teeth are found to be similar to two of the four upper right symphyseal teeth in *C. mantelli*. Siverson (1992) also noted that symphyseal teeth (his 'parasymphyseal teeth') of *C. mantelli* are similar to those of *Cretalamna appendiculata*. Thus, they are interpreted to be upper symphyseal teeth in *C. appendiculata*.

### Reconstructed Dentition

**General Remarks**—The reconstructed dentition (Figs. 5C, 7), which is partially corroborated with some teeth still in situ on the right palatoquadrate (Fig. 6C), implies that the shark had a lamnoid tooth pattern (sensu Compagno, 1984; Shimada, 2002a). At least 15 upper tooth rows were present on each side, consisting of at least two symphyseal, two anterior, one intermediate, and at least 10 lateral tooth rows (Figs. 5C, 7). The lower dentition is poorly represented in LACM 128126, but it apparently consisted of more than eight tooth rows on each side including two anterior, one intermediate, and at least five lateral tooth rows (Figs. 5C, 7). In dental formula, the tooth arrangement can be expressed as:

$$\frac{S2(+?) \quad A2 \quad I1 \quad L10(+?)}{s? \quad a2 \quad i1 \quad l5+}$$

where 'S' and 's' refer to symphyseal, 'A' and 'a' anterior, 'I' and 'i' intermediate, and 'L' and 'l' lateral tooth rows (sensu Shimada, 2002a).

The reconstructed dentition of *Cretalamna appendiculata* in relation to the length of the jaw cartilage (Fig. 7b) indicates that adjacent tooth roots abut each other and do not overlap. This tooth row arrangement is called 'juxtaposed dentition' (Welton and Farish, 1993). It is a form of 'independent dentition' (sensu Compagno, 1988; see Shimada and Cicimurri, 2005).

It is possible that the shark could have possessed more than two rows of upper symphyseal teeth given that *Cretoxyrhina mantelli* had up to four upper symphyseal tooth rows (see Shimada, 2002a). Because the smallest upper lateral tooth (L10) is much smaller than the smallest lower lateral tooth (l5), and because the reconstructed lower dental series is much shorter than the upper dental series (Fig. 7), some post-l5 teeth are likely not preserved in the specimen. The presence of teeth distal to L10 in the upper dentition is uncertain although it would have been only one or two more rows, if any, given the total length of the dental series in relation to the length of the palatoquadrate (see Fig. 7B).

**Upper Symphyseal Teeth**—Principal cusp small and curved mesiolingually; crown height and principal cusp height similar to crown width and principal cusp width, respectively; lateral cusplet represented as minute heel on mesial side; one small lateral cusplet on distal side; basally directed distal root lobe much longer than mesial lobe; basal root concavity tight; lingual root surface robust without clear separation of lingual protuberance (at least in 'S2': Fig. 8).

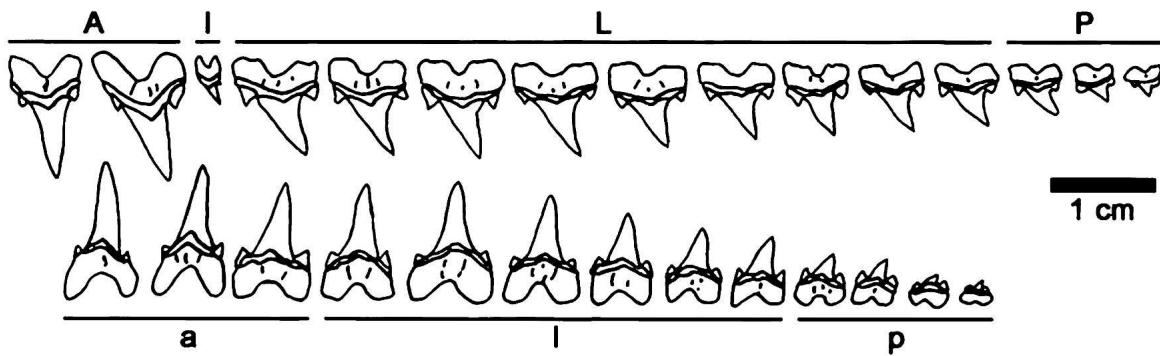

**A**

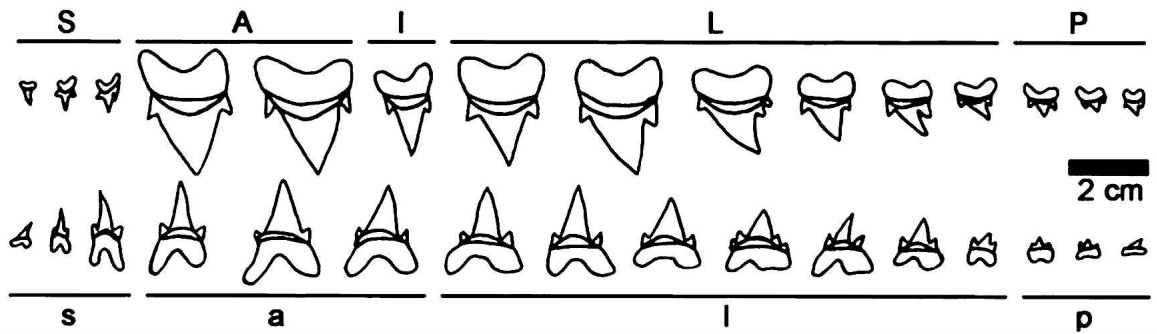

**B**

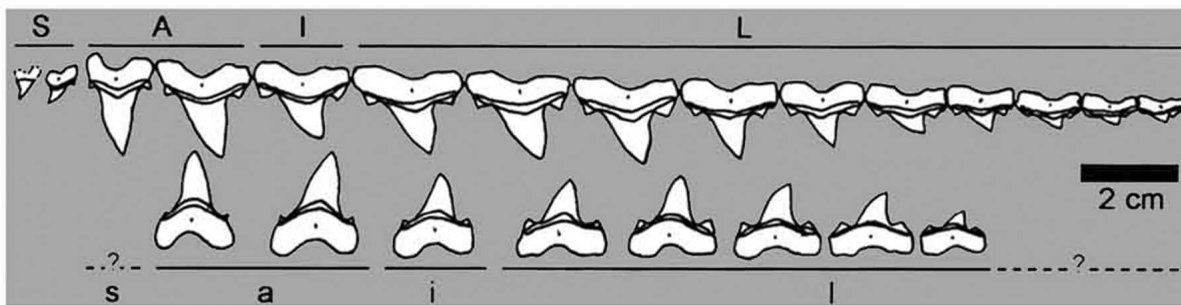

**C**

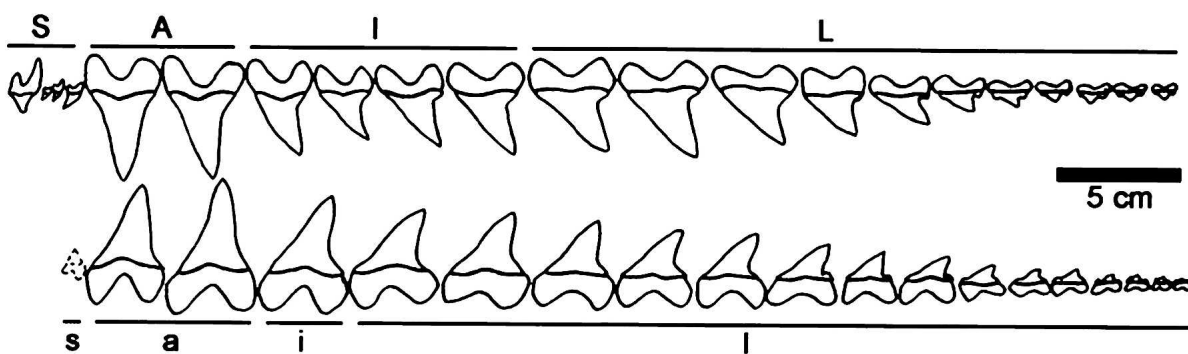

**D**

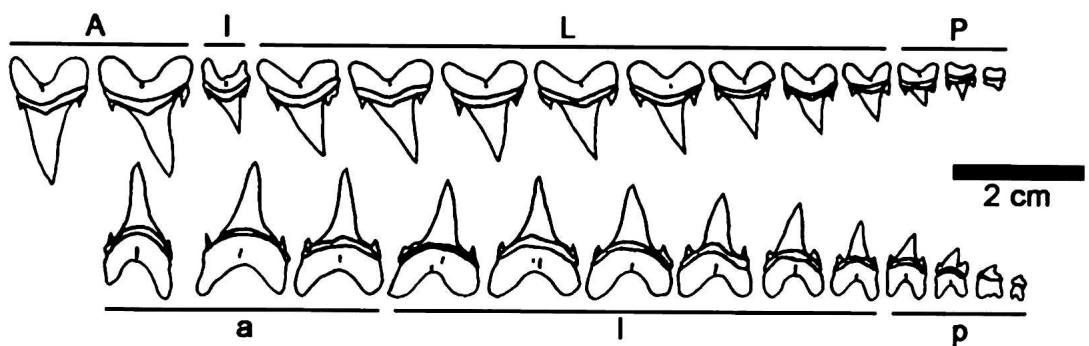

**E**

Based on *Cretoxyrhina mantelli* (Shimada, 2002a), the 'S1' is interpreted to be smaller than the 'S2.' The mesial curvature of the crown in the 'S2' is stronger than that in the 'S1' (note that the abbreviation 'S' is in quote marks to denote the uncertainty in interspecific homology within this tooth type: see Shimada, 2002a)

**Lower Symphyseal Teeth**—The specimen does not preserve any remains referable to lower symphyseal teeth. However, it is quite possible that the lower dentition originally contained one or more rows of symphyseal teeth. For example, Shimada (1997a, 2002a) reported the presence of at least one row of small lower symphyseal teeth in *Cretoxyrhina mantelli* based on radiographic images (note: its morphology is uncertain but appears to be asymmetrical).

**Upper and Lower Anterior Teeth**—Cusp large and erect or slightly inclined distally; principal crown height greater than its width; mesial and distal root lobes about equal in length; basal root concavity relatively tight; lingual root protuberance high but medially constricted.

The root lobes of lower anterior teeth are more robust than those of the upper ones. The a1 has the most symmetrical principal cusp among the anterior teeth, whereas the a2 is the tallest tooth in the entire mouth. Although the crown width is narrower without any significant difference in the principal cusp width, the A2 closely resembles the L1 (see below). The principal cusp of the A2 in profile is straight, whereas it is slightly curved lingually in other anterior teeth.

**Upper Intermediate Tooth**—Tooth height shorter than preceding A2 and following L1; principal cusp height lesser than its width; principal cusp strongly curved distally; mesial and distal root lobes broad and about equal in size, each with weak indentation along basal edge; basal root concavity broad; lingual root protuberance less prominent than that of anterior teeth.

The I1 is similar to the L4 in size and overall morphology. However, it differs by exhibiting much inclined principal cusp than the L4 (note: much longer mesial cutting edge length in the I1 than in the L4 in relation to their distal cutting edge length: Appendix 1).

**Lower Intermediate Tooth**—Tooth height shorter than preceding a2 and taller than following I1; principal cusp height greater than its width; principal cusp slightly inclined distally; mesial root lobe slightly longer than the distal root lobes; basal root concavity moderately broad; lingual root protuberance less prominent than that of anterior teeth.

The i1 shows an intermediate morphology between the a1 and I1. Its root is less robust than the a1 but narrower than I1, and its principal cusp is narrower and more erect than that of the L1 but shorter than the a1. The erect appearance of the cusp comes from the gently concaved basal half of the mesial cutting edge and less distally inclined cusp tip compared to the I1.

**Upper and Lower Lateral Teeth**—Tooth height shorter than anterior teeth; tooth height and crown height lesser than tooth width and crown width, respectively; except for L1–L4, principal cusp height lesser than principal cusp width; inclination of principal cusp moderate to strong from A1 or a2 to distal-most tooth in each dentition; mesial root lobe about equal to distal lobe in size; base of each lobe flat or weakly indented; basal root concavity broad; lingual root protuberance weak.

All lateral teeth have a distally inclined principal cusp. The L1

and I2 are the tallest lateral teeth in the upper and lower dentitions, respectively. From mesially located lateral teeth to distally located lateral teeth, the size (especially the height) of the lateral cusplets decreases more gradually than the size of the principal cusp. The crown height in distally located lateral teeth is about three times shorter than its crown width in the upper dentition. Teeth at the distal portion of the lower dentition are poorly represented in the tooth set, but the crown height in the I5 is about twice as short as its crown width. Each lateral cusplet in distally located lateral teeth (e.g., L4–L10 and I5) may bear a minute additional lateral cusplets laterally.

## DISCUSSION

### Comparisons of Reconstructed Dentitions

My reconstructed dentition of *Cretalamna appendiculata* (Fig. 5C) differs from the artificial dentition proposed by Welton and Farish (1993) (Fig. 5A) and that by Applegate and Espinosa-Arrubarrena (1996) (Fig. 5B). Welton and Farish (1993) showed one intermediate tooth that was significantly smaller in size compared to its adjacent teeth (Fig. 5A). Whereas their reconstruction did not include any rows of symphyseal teeth, I believe that their illustrated intermediate tooth is actually a symphyseal tooth based on its size and morphology. It is uncertain whether or not an intermediate tooth is actually included in their illustration. On the other hand, Applegate and Espinosa-Arrubarrena (1996) showed three rows of symphyseal teeth in both upper and lower dentitions (Fig. 5B). This interpretation is plausible considering the fact that lower teeth are especially poorly represented in LACM 128126, and that *Cretoxyrhina mantelli* (Fig. 5D) had four rows of upper symphyseal teeth. Another noticeable difference is that the principal cusp of the intermediate tooth illustrated by Applegate and Espinosa-Arrubarrena (1996) is erect, whereas I found the principal cusp of the tooth to be strongly inclined distally. Welton and Farish (1993) and Applegate and Espinosa-Arrubarrena (1996), illustrated three rows of lower anterior teeth (without any rows of lower intermediate teeth) and multiple rows of posterior teeth, but the differences between my and their reconstructions in regards to these teeth are a matter of different tooth type nomenclatures used.

The reconstructed dentition of *Cretoxyrhina mantelli* (Fig. 5D) is based on an articulated tooth set (Shimada, 1997a), representing the most objectively reconstructed fossil lamniform dentition to date (vs. Welton and Farish, 1993; Applegate and Espinosa-Arrubarrena, 1996; Kent and Powell, 1999; Siverson, 1999; Gottfried and Fordyce, 2001; Purdy et al., 2001). The tooth set is more complete than that of *Cretalamna appendiculata* described here. The most noticeable differences in dentition between *C. appendiculata* (Fig. 5C) and *Cretoxyrhina mantelli* (Fig. 5D) is that the latter has more rows of upper intermediate teeth than the former. There are more symphyseal teeth in *C. mantelli* (Fig. 5D) than *Cretalamna appendiculata* (Fig. 5C), but this may be simply due to poorer preservation in the examined *C. appendiculata* specimen.

The name '*Cretalamna*' stands for 'Cretaceous *Lamna*.' *Lamna* is a Cenozoic lamniform genus that includes two dentally similar extant species, *L. nasus* and *L. ditropis* (for their subtle differences, see Nakaya, 1971). Figure 5E shows the traditional

FIGURE 5. Previously reconstructed dentitions of *Cretalamna appendiculata* (A, Welton and Farish, 1993, fig. 14, p. 104; B, Applegate and Espinosa-Arrubarrena, 1996, fig. 7), newly reconstructed dentition of *C. appendiculata* (C, this study), dentition of cretoxyrhinid lamniform, *Cretoxyrhina mantelli* (D, Shimada, 1997a, 2002a), and dentition of modern lamnid, *Lamna nasus* (E, Welton and Farish, 1993, fig. 14). All mesial to the left; all in lingual view except D; spaces between lower teeth depicted in C are artifacts (i.e., all teeth were likely juxtaposed one another in life). **Abbreviations:** A, upper anterior tooth; a, lower anterior tooth; I, upper intermediate tooth; i, lower intermediate tooth; L, upper lateral tooth; I, lower lateral tooth; P, upper posterior tooth; p, lower posterior tooth; S, upper symphyseal tooth; s, lower symphyseal tooth.



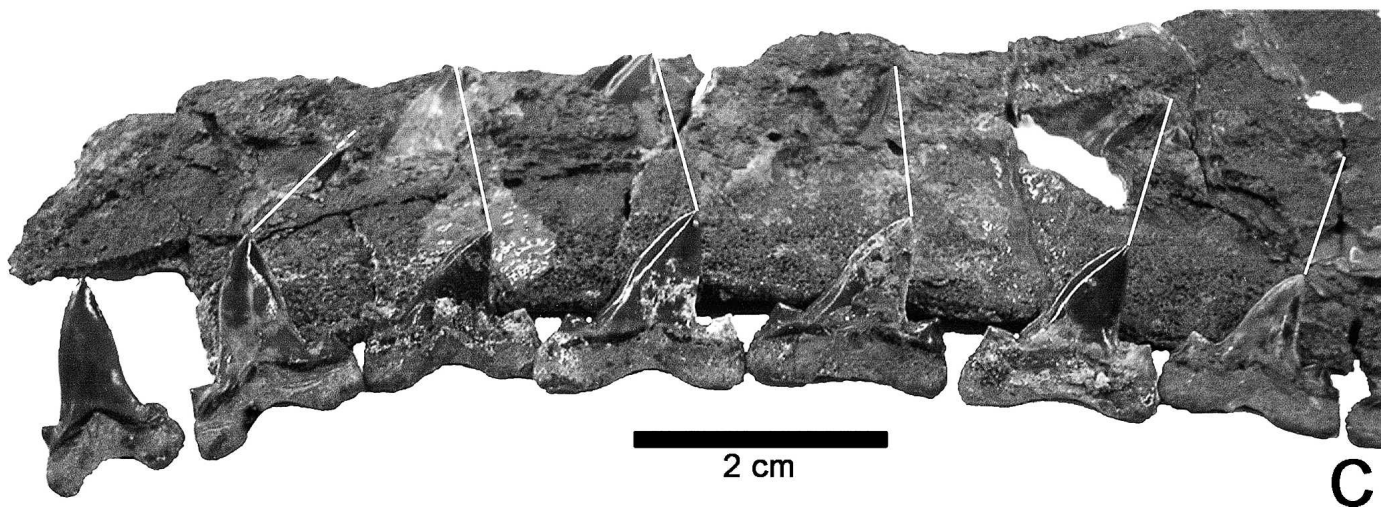
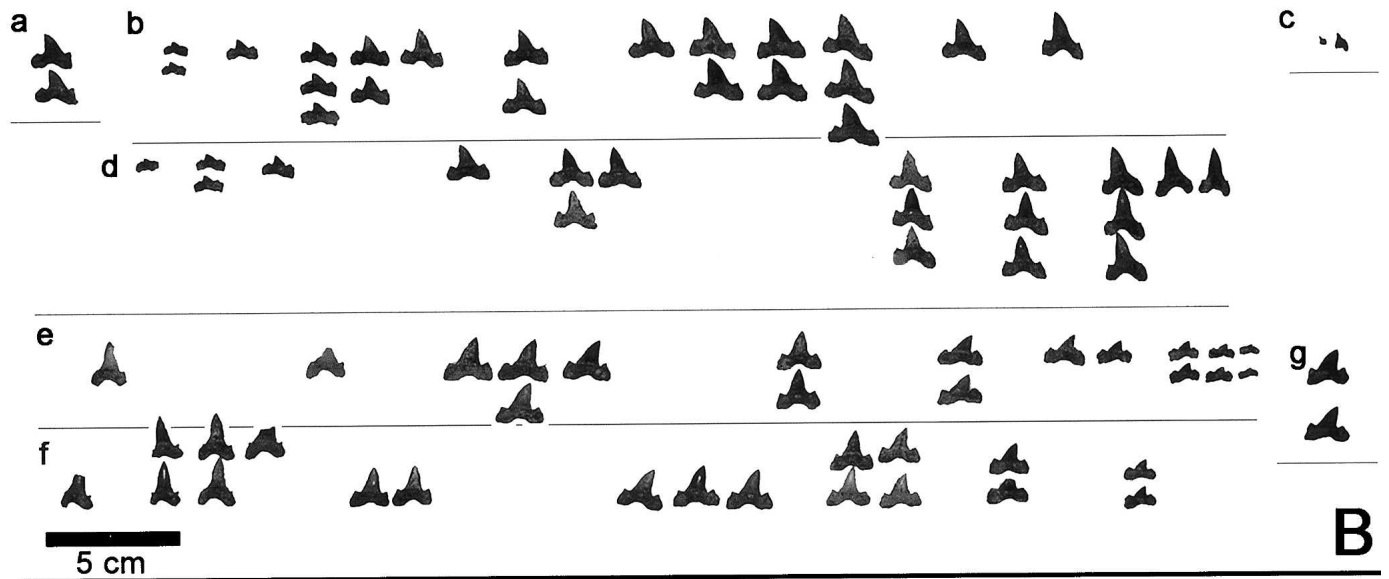
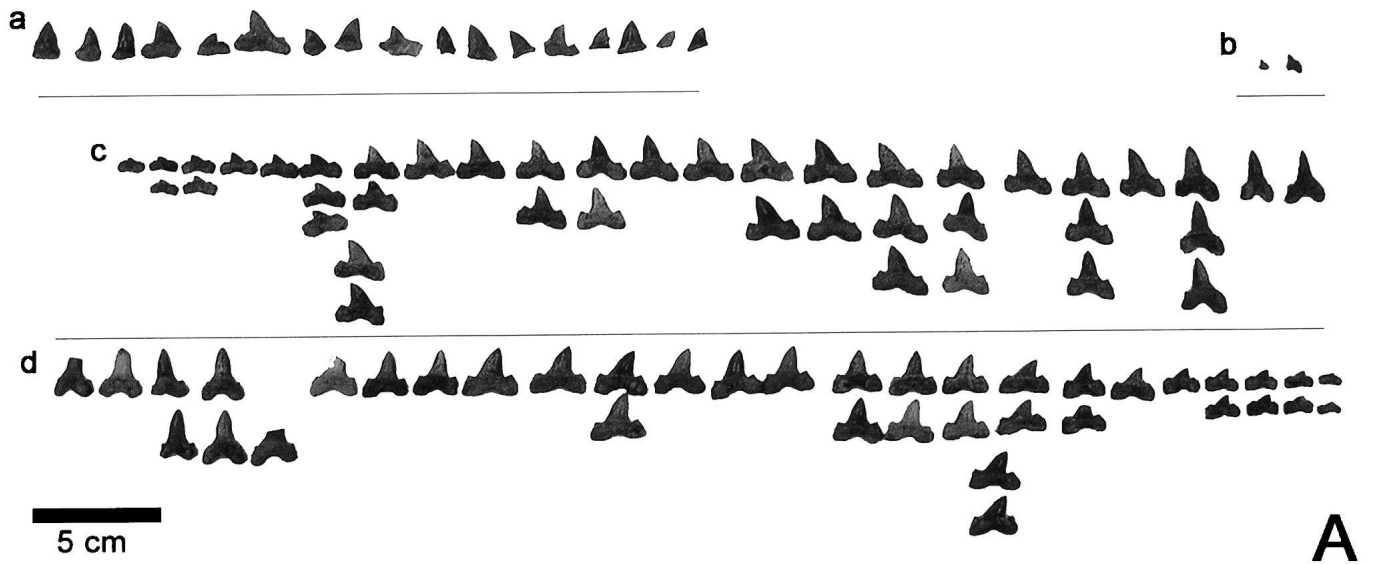

tooth type classification in which the third large lower tooth from the symphysis is called the third anterior tooth and the distal-most teeth in each dentition are referred to posterior teeth. Shimada's (2002a) tooth type classification scheme refers to the former as the lower intermediate tooth and the latter as the distal-most lateral teeth. Teeth of *Lamna* (Fig. 5E) differ from teeth of *C. appendiculata* (Fig. 5C) by possessing a narrower principal cusp and lateral cusplets. However, whereas the upper intermediate tooth is much smaller in *Lamna* compared to that of *C. appendiculata*, it is noteworthy that the overall dental pattern of *C. appendiculata* is more similar to the dental pattern of *Lamna* than to that of *Cretoxyrhina mantelli* (Fig. 5D). Although lower symphyseal teeth were not found in LACM 128126, it is also intriguing that Glickman and Dolganov (1988) documented a specimen of modern *L. ditropis* with a row of small symphyseal teeth, similar to the identified symphyseal teeth of *Cretalamna appendiculata* and *Cretoxyrhina mantelli*. As in the traditional view (e.g., Cappetta, 1987), the observed differences in tooth morphology between *Lamna* and *Cretalamna appendiculata* may indicate that *C. appendiculata* is not phylogenetically closely allied to *Lamna* within Lamniformes. If so, the observed resemblance in dental pattern between the two taxa is homoplasious due to convergent evolution. However, the tooth morphology and the number of intermediate tooth rows are significantly different between *C. appendiculata* and *Cretoxyrhina mantelli*, thus warranting the possibility that *Cretalamna appendiculata* does not belong to Cretoxyrhinidae as proposed by Siverson (1999).

### Jaw Morphology

In *Cretalamna appendiculata*, the Meckel's cartilage is found to be mesiodistally shorter than the palatoquadrate. Whereas the posterior end of the upper and lower jaws met as a mandibular articulation, this condition implies that the anterior margin of the upper jaws extended forward beyond that of the lower jaws. It concomitantly implies that *C. appendiculata* had a subterminal mouth as the upper jaws overbit the lower jaws. However, especially because the symphyseal region of the palatoquadrate is poorly preserved in LACM 128126, exactly how the jaws were suspended from the skull is uncertain for the species (e.g., see Wilga, 2005).

The shape of jaw cartilages in sharks is generally difficult to describe because the cartilages consist of curved surfaces with only few anatomical landmarks available. However, it is noteworthy that the overall outline of both upper and lower jaws in *Cretalamna appendiculata* resembles that of modern alopiids (*Alopias*) and lamnids (*Lamna*, *Isurus*, and *Carcharodon*; e.g., see Wilga, 2005) as well as *Cretoxyrhina mantelli* (see Shimada, 1997b). The jaw morphology in these lamniforms is characterized by a dorsally expanded quadrate process in palatoquadrate and a ventrally expanded posteroventral corner in Meckel's cartilage, indicating the presence of a set of massive dorsal and ventral quadratomandibularis muscles (sensu Wilga, 2005) for powerful jaw adduction. The morphology contrasts with that in the basal most lamniform taxon, Mitsukurinidae (Cappetta, 1980; Wilga, 2005), as well as in *Carcharias taurus*, where jaw cartilages are elongated anteroposteriorly with a restricted space for the attachment to the dorsal and ventral quadratomandibularis muscles (see Wilga, 2005). The difference is likely the re-

flexion of the function of teeth. Teeth in alopiids, lamnids, and *Cretoxyrhina*, are relatively broad and have well-marked mesial and distal cutting edges suited for cutting (Shimada, 2005). On the other hand, teeth in mitsukurinids and *Carcharias* are narrow and delicate, which are suited for grasping (Shimada, 2005). The fact that the jaw morphology of *Cretalamna appendiculata* resembles that of modern alopiids and lamnids does not contradict to this observation because *C. appendiculata* has broad teeth with prominent mesial and distal cutting edges on both the principal cusp and paired lateral cusplets indicative of cutting function (for further discussion on feeding mechanics, see below).

### Body Form

The body form of all modern lamniforms is fusiform (Compagno, 2001) but can be broadly classified into two categories: (1) a body with a conical head, lateral fluke on the caudal peduncle, and lunate caudal fin (e.g., *Cetorhinus*, *Carcharodon*, *Isurus*, and *Lamna*); and (2) a body with a head that has a flattened ventral surface, no lateral fluke on the caudal peduncle, and elongated upper lobe of the caudal fin (e.g., *Carcharias* and *Alopias*) (Thomson and Simanek, 1977). The skeletal elements preserved in LACM 128126 do not show direct evidence indicating the morphology of the head, caudal peduncle, and caudal fin of *Cretalamna appendiculata*. However, given the fact that all modern lamniforms have fusiform body, it is reasonable to assume that *C. appendiculata* also had a fusiform body. Although a broad survey of correlating the vertebral shape with the body form in elasmobranchs is needed, it is true that modern pelagic sharks with a fusiform body have circular vertebral centra, whereas at least some true benthic sharks, such as *Squatina*, have dorsoventrally compressed vertebral centra (see Applegate, 1967; Compagno, 1977). The centra in *C. appendiculata* are circular, and therefore the observation does not contradict with the interpretation that *C. appendiculata* possibly had a fusiform body.

Extant lamniforms that do not rely on teeth for prey capture, such as *Megachasma*, *Cetorhinus*, and *Alopias*, tend to possess smaller teeth relative to the jaw size (Shimada, 2005). Whereas *Megachasma* and *Cetorhinus* are filter-feeding planktonivorous sharks, *Alopias* spp. are macrophagous sharks but differ from other macrophagous lamniforms in their feeding habit in that they use their elongated tail as a stunning device to assist prey capture (e.g., Gubanov, 1972; Stillwell and Casey, 1976). Although the exact body form of *Cretalamna appendiculata* can only be speculated at the present time, the tooth size in *C. appendiculata* is prominent in relation to the size of its jaws indicating that teeth were important for prey capture for the fossil shark. This contention concomitantly implies that the upper lobe of its caudal fin was not needed to be elongate. Perhaps, it was moderately elongated as in modern *Carcharias* or was as short as in *Cretoxyrhina* (see Shimada, Cumbaa et al., 2006) and modern *Cetorhinus*, *Carcharodon*, *Isurus*, and *Lamna* (see Thomson and Simanek, 1977).

### Body Size

LACM 128126 is a fragmentary skeleton. However, some inferences about the total length (TL) of the *Cretalamna appen-*

←

FIGURE 6. Reconstructing dentition of *Cretalamna appendiculata* based on LACM 128126 (see text for detail). **A**, separating teeth based on size and crown inclination (**a**, excluded poorly mineralized teeth; **b**, putative symphyseal teeth; **c**, crown inclining to the left; **d**, crown inclining to the right); **B**, putatively separating upper teeth from lower teeth (**a**, putative intermediate teeth; **b**, putative upper right teeth; **c**, putative symphyseal teeth; **d**, putative lower left teeth; **e**, putative upper left teeth; **f**, putative lower right teeth; **g**, putative intermediate teeth); **C**, mesial end of right palatoquadrate (lingual view) with some replacement teeth in situ, which are compared to putative arrangement of upper right teeth (Fig. 6Bb) and are used to identify intermediate teeth (Fig. 6Ba).

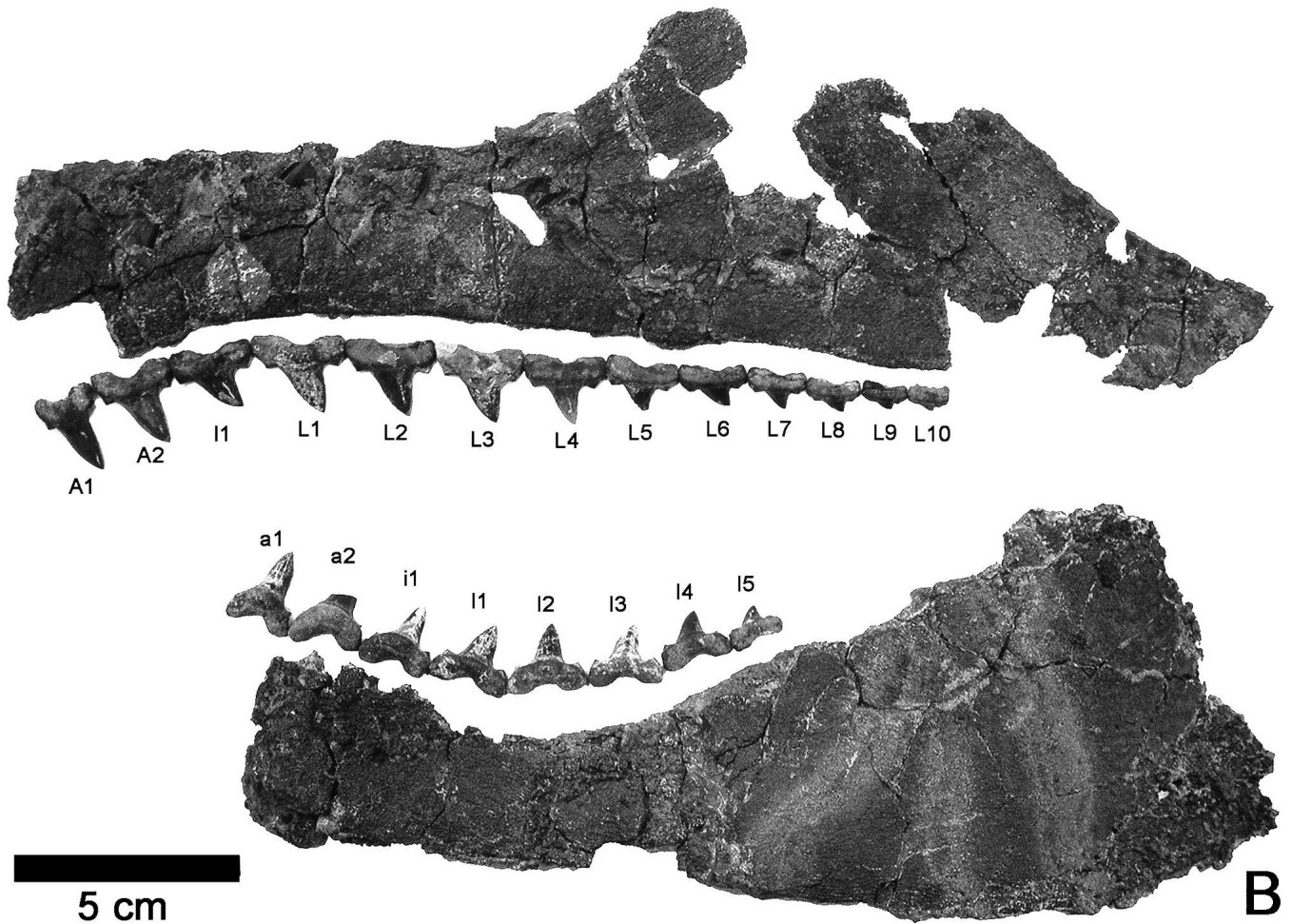
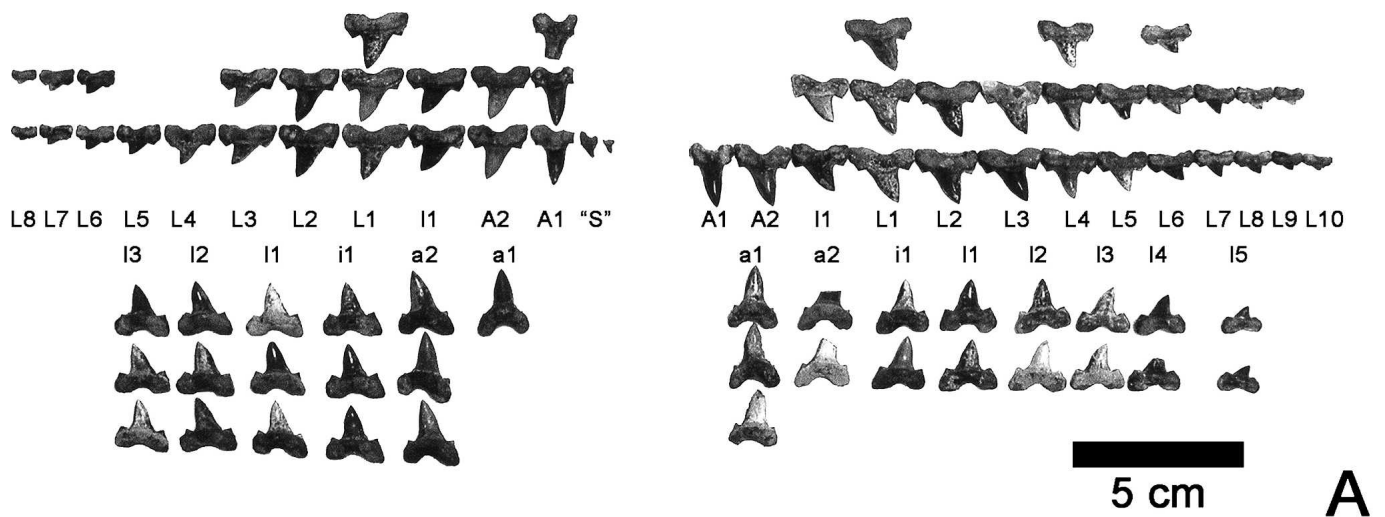

FIGURE 7. Reconstructed dentition (lingual view) of *Cretalamna appendiculata* based on LACM 128126. **A**, all identified teeth; **B**, reconstructed right upper and right lower dentitions (symphyseal teeth omitted) placed along the margin of palatoquadrate (top: right jaw in lingual view) and Meckel's cartilage (bottom: left jaw in labial view). **Abbreviations:** as for Fig. 5.

*diculata* individual in life can be made based on the diameter (40 mm) of the best preserved vertebra (v9), which is one of the largest centra in the vertebral column. One possible approach is to compare the diameter with the previously published data on

the relationship between the TL and vertebral diameter (VD) in *Cretoxyrhina mantelli* (Shimada, 1997b). The largest centrum measures 87 mm in VD in the best skeleton of *C. mantelli*, which has a conservative TL estimate of 500 cm (Shimada, 1997b).

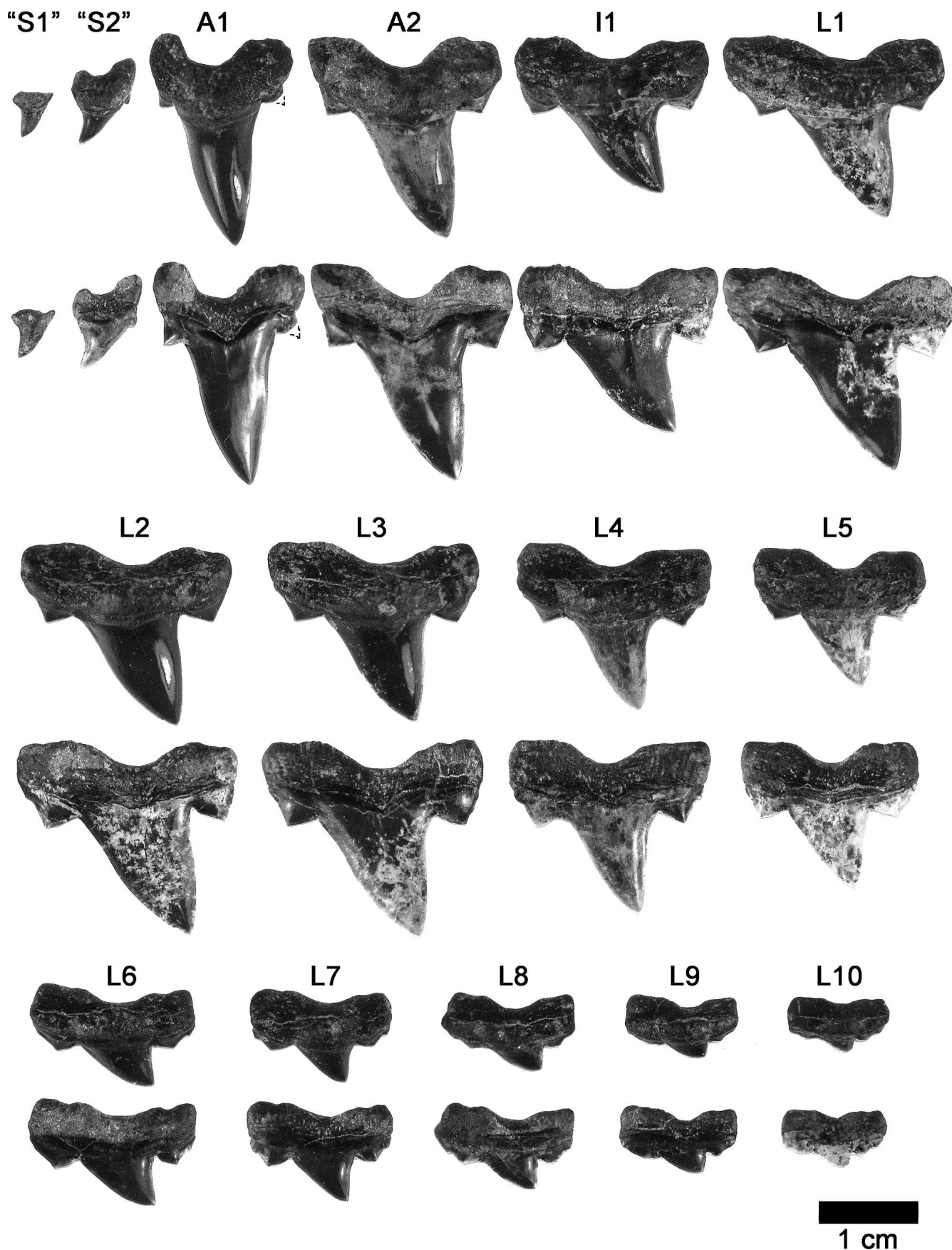

FIGURE 8. Close-up view of upper teeth of *Cretalamna appendiculata* (LACM 128126; cf. Fig. 7A). Top row = lingual view (depicting upper right dentition); bottom row = labial view (images reversed to depict upper left dentition). **Abbreviations:** as for Fig. 5. Note that "S1" and "S2" are from the left dentition (cf. Fig. 7A), but their images are properly reversed.

Because the largest, least distorted vertebra in LACM 128126 (40 mm in VD) is 46% of the *C. mantelli* vertebra, the TL of the *Cretalamna appendiculata* individual is conservatively extrapolated to be approximately 230 cm.

Another possible approach is to examine how the vertebral size of *Cretalamna appendiculata* fits to known quantitative relationships between vertebral size and TL in extant lamniform taxa. Appendix 2 lists published equations correlating either the vertebral diameter (VD) or vertebral radius (VR) with the TL in modern lamniforms. Then, I mathematically estimated the TL ('TL<sub>est</sub>' in Appendix 2) based on each equation using the VD of 40 mm (which reflects the diameter of the best preserved vertebra in LACM 128126) or the VR of 20 mm (which is half of the VD). The results (Appendix 2) indicate that the TL estimation for LACM 128126 depends on the inference about the length of the caudal fin. Notably, *Alopias* spp., which have a caudal fin nearly the same length as the pre-caudal length, give TL estimations that exceed 4 m. However, because the upper lobe of the caudal fin in *C. appendiculata* was probably not as elongate as in modern *Alopias* (see above), the fossil shark was probably much less than 4 m TL. The TL estimations for non-*Alopias* taxa range from 2.5 to 3.8 m (Appendix 2), and the mean of the mean TL estimations among these lamniforms is about 3 m. Given the fact that the conservative TL estimation for LACM 128126 based on *Cretoxyrhina mantelli* is 2.3 m, it is likely that the *Cretalamna appendiculata* individual measured 2.3–3 m TL.

#### *Cretalamna* as a Lamniform

On the basis of tooth morphology, which is characterized by a large, triangular principal cusp, a large bilobed root, and osteodont histology, *Cretalamna appendiculata* has been classified into the order Lamniformes (e.g., Cappetta, 1987). Applegate (1970) illustrated a transverse cross section of vertebra of *C. appendiculata*, which revealed numerous well-calcified radial cartilage lamellae radiating from its center, and LACM 128126 confirms the presence of such radial lamellae (Fig. 3D). Compagno (1990:370) and Shirai (1996:18) described this feature as "primary exochordal radii" and "endochordal radii radiating from the notochordal sheath," respectively, and regarded as one of a few synapomorphies of Lamniformes, even though this character also occurs parallel in non-parascylliid orectolobiforms (Shirai, 1996). Whereas there is no indication of *C. appendiculata* belonging to Orectolobiformes, the presence of radiating lamellae in vertebrae coupled with the general dental morphology strongly indicates that *C. appendiculata* is a lamniform.

The monophyly of Lamniformes is supported by genetic data (Martin and Naylor, 1997; Naylor et al., 1997) as well as by a few morphological characters (e.g., Shirai, 1996). Besides the radial lamellae in vertebrae, Compagno (1990) listed three other morphological synapomorphies of Lamniformes: (1) the lamnoid tooth pattern, (2) reduction of labial cartilages, and (3) elongated ring type intestinal valve with over 15 turns. Shirai (1996) and Carvalho (1996) recognized the ring type intestinal valve as a synapomorphy of Lamniformes but not the others. However, Carvalho (1996) noted the presence of dental bullae on the jaw cartilages as one of three potential, additional synapomorphies of Lamniformes (note: other two characters are lateral rostral fenestrae and rostral apex). Subsequently, Shimada (2002a) regarded the presence of upper and lower dental bullae as a shared derived character of Lamniformes with the assumption that (1) the dental bullae in the two microphagous forms, *Megachasma* and *Cetorhinus*, are secondarily lost, and that (2) the presence of dental bullae in *Hemipristis elongatus* (Carcharhiniformes) is a result of convergence.

The presence of dental bullae is directly related to the presence of the lamnoid tooth pattern (Shimada, 2002a). Shimada (2002a) noted that the dental bullae are more definable than the

lamnoid tooth pattern but also added that listing both the dental pattern and bullae as two separate synapomorphies for Lamniformes would be redundant. The reconstructed dentition of *Cretalamna appendiculata* (Fig. 5C) revealed that the fossil taxon had the lamnoid tooth pattern. The reconstruction was initially conducted under the assumption that *C. appendiculata* belongs to Lamniformes. However, it must be emphasized that the presence of the lamnoid tooth pattern is confirmed independently on the basis of replacement teeth preserved in situ on the right palatoquadrate (Fig. 6C). Therefore, postulating that *Cretalamna appendiculata* had a lamnoid tooth pattern is no longer a circular argument but an empirical observation.

Shimada (2002a) noted the probable presence of the dental bullae in the palatoquadrates of a Cretaceous mitsukurinid, *Scapanorhynchus lewisii*, based on illustrations presented by Davis (1887: plate 14) and Cappetta (1980: plates 8–10). However, probably because the jaw cartilage, particularly the part that makes up the dental bulla, is thin and is likely difficult to be fossilized, dental bullae have not been recorded in other fossil lamniforms, including the *Cretalamna appendiculata* individual described here. Nevertheless, the close proximity between the replacement tooth of the A2 (pointed by the left-most line in Figure 6C) and that of the I1 (pointed by the second line from the left in Figure 6C), compared to the distance between the other replacement teeth in situ on the jaw, appears to reflect the 'crowded' tooth rows at the mesial end of the palatoquadrate. This condition appears to indicate the presence of a dental bulla (e.g., see Shimada, 2002a:fig. 3). If so, *C. appendiculata* had a dental bulla on each palatoquadrate.

The functional diversity of feeding mechanism in elasmobranchs is large, but their feeding apparatus is surprisingly simple by consisting of only 10 cartilaginous elements (Motta, 2004). Therefore, one can argue that the skeletal evolution is conservative in elasmobranchs. Yet, an enormous morphological diversity seen in teeth of extinct and extant elasmobranchs (e.g., Compagno, 1984; Cappetta, 1987) indicates that their dental morphology readily responds to selection pressures present in their environment. In his study of correlating the osteological data with the soft tissue anatomy in various archosaurs, Witmer (1997:2) called attention to Moss's (1968) phrase 'soft tissues evolve, bones respond' in order to highlight the notion that "bones must be studied in concert with their associated soft tissues." I take a similar approach by stating that 'teeth evolve, jaw cartilages respond' with the notion that jaw cartilages must be studied in concert with their associated dental components. Specifically, the presence of dental bullae is assumed to be associated with the lamnoid tooth pattern. This notion justifies the inference about the presence of the dental bulla in each jaw cartilage of *Cretalamna appendiculata* on the basis of Witmer's (1997) 'extant phylogenetic bracket approach.'

The extant phylogenetic bracket approach uses a phylogeny of a monophyletic group of extinct and extant taxa to infer unfossilized features in extinct taxa from anatomical correlates universally found in taxa represented in the cladogram (Witmer, 1997). The systematic relationship among lamniform taxa is still in debate due to conflicting results particularly between morphological (Compagno, 1990; Shirai, 1996; Shimada, 2005) and molecular (Naylor et al. 1997) studies. Nevertheless, Figure 11 shows a consensus tree among those studies, and *Cretalamna* is tentatively inserted as a distinct taxon with more derived features (e.g., cutting type teeth: see Shimada, 2005) than in Mitsukurinidae but not belonging to Lamnidae (see above) or the filter-feeding Cetorhinidae. The lamnoid tooth pattern (denoted as character 'A' in Figure 11) is present in all extant lamniforms except the only two filter-feeding taxa, Megachasmidae and Cetorhinidae (note that one of the alopiid species, *Alopias superciliosus*, appears to possess the lamnoid tooth pattern only during its embryonic stage: Shimada, 2002a). Likewise, the dental

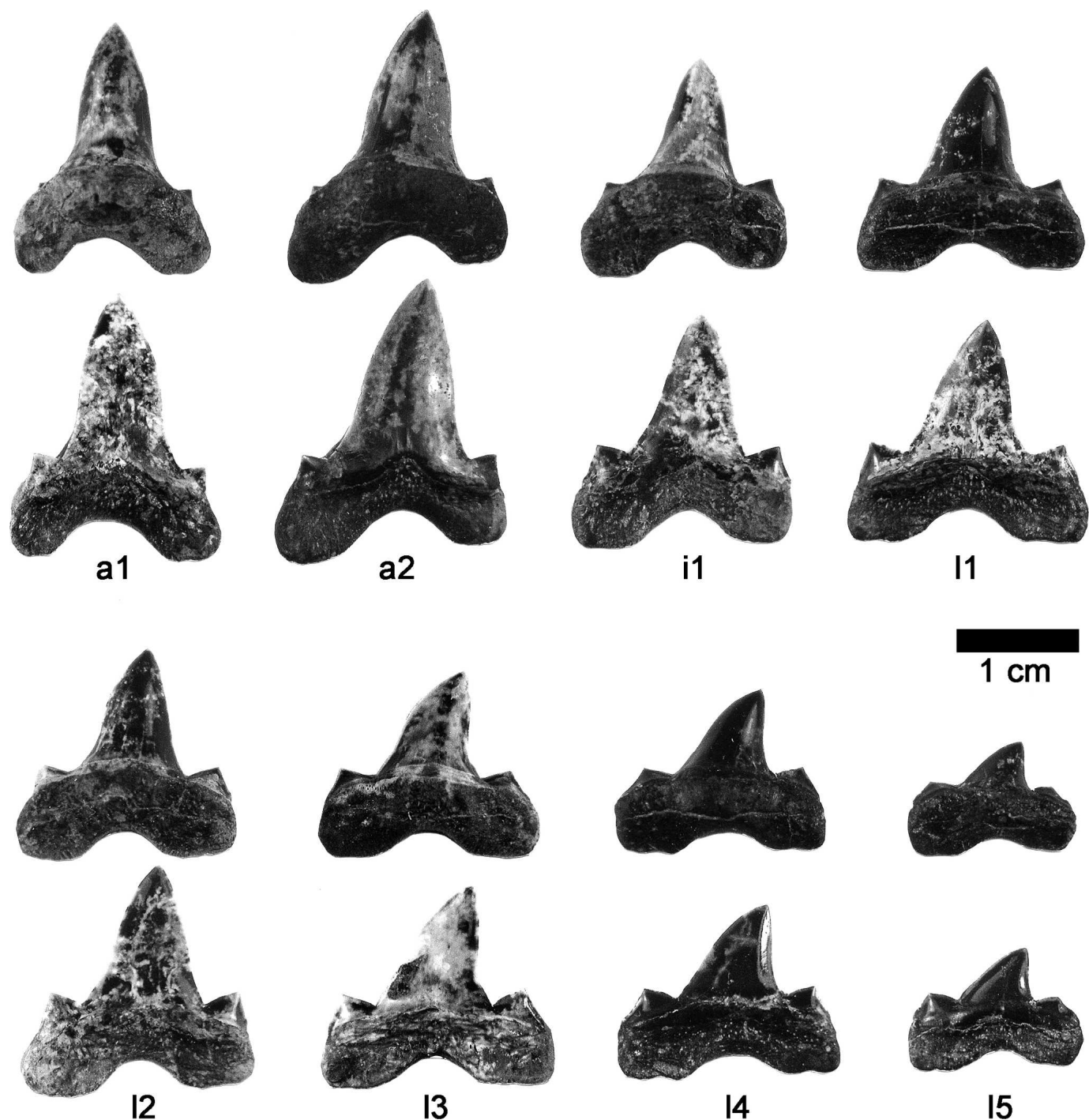

FIGURE 9. Close-up view of lower teeth of *Cretalamna appendiculata* (LACM 128126; cf. Fig. 7A). Top row = lingual view (depicting lower right dentition); bottom row = labial view (images reversed to depict lower left dentition). **Abbreviations:** as for Fig. 5. Note that a2 is from the left dentition (cf. Fig. 7A), but its images are properly reversed.

bulla (denoted as character 'B' in Figure 11) is present in each upper and lower jaw cartilage in all extant lamniforms except Megachasmidae and Cetorhinidae (note that dental bullae are present in *Alopias superciliosus*; Shimada, 2002a). Assuming that the absence of the lamnoid tooth pattern and dental bullae in Megachasmidae and Cetorhinidae is a secondary loss due to its specialization in planktonic feeding (Shimada, 2002a, 2005), the extant phylogenetic bracketing dictates the proposition that *C. appendiculata* that had the lamnoid tooth pattern likely pos-

sessed dental bullae because all extant macrophagous lamniforms possess the lamnoid tooth pattern and dental bullae.

It is noteworthy that another fossil lamniform, *Cretoxyrhina mantelli*, was found to possess a lamnoid tooth pattern on the basis of an articulated tooth set (Shimada, 1997a), but there was no direct evidence for the presence of dental bullae (Shimada, 1997b, 2002a) although Siverson (1999) inferred that it had the bullae (his 'anterior hollow') based on observed 'crowding' of mesially located tooth rows. However, if one replaces '*Cre-*

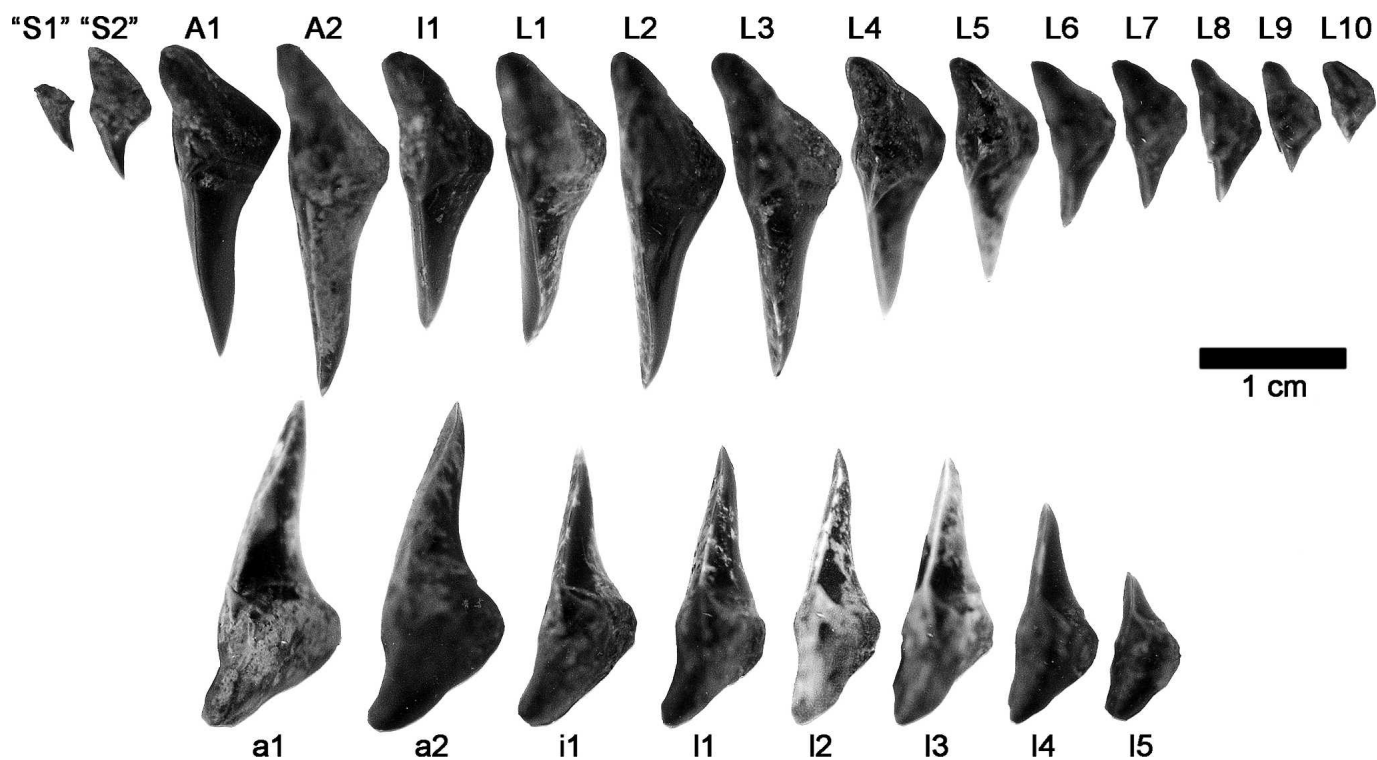

FIGURE 10. Mesial view of upper (top) and lower (bottom) teeth of *Cretalamna appendiculata* depicted in Figures 8 and 9 (LACM 128126: cf. Fig. 7A). **Abbreviations and specifications:** as for Figs. 8 and 9.

*talamna*' in Figure 11 with '*Cretoxyrhina*,' the same extant phylogenetic bracketing indicates that *C. mantelli* must have had a dental bulla in each jaw cartilage. There are other fossil lamniforms with tentative reconstructed dentitions (e.g., Welton and Farish, 1993; Applegate and Espinosa-Arrubarrena, 1996; Kent and Powell, 1999; Siverson, 1999; Gottfried and Fordyce, 2001; Purdy et al., 2001). However, it must be noted that the extant phylogenetic bracket approach cannot be employed for these extinct sharks, because their reconstructed dental patterns are artificial based on one or more isolated or disarticulated tooth sets (sensu Shimada, 2006a) using the dental pattern of extant lamniform sharks as templates. For extinct lamniforms to be incorporated into the extant phylogenetic bracketing study, the presence of the lamnoid tooth pattern must be substantiated first by direct evidence.

### Paleoecology

LACM 128126 occurred in the uppermost part of the Smoky Hill Chalk Member of the Niobrara Chalk. The stratigraphic member is 180 m thick and formed under the Western Interior Sea, an epicontinental sea that extended in a north-south direction in the middle of the North American continent over about five million years (Obradovich and Cobban, 1975, p. 50). The Smoky Hill Chalk is rich in fossil vertebrates comprising at least 16 chondrichthyan and 54 osteichthyan fish taxa (Shimada and Fielitz, 2006) as well as various tetrapod taxa including at least six marine turtles, 10 squamates (one dolichosaur and nine mosasaur taxa), four plesiosaurs, three pterosaurs, seven birds, and three non-avian dinosaurs (see table 13.1 of Everhart [2005], which is based on Russell [1988], Stewart [1990], and Carpenter [2003]; Shimada and Bell, 2006). However, it must be noted that the 'Niobrara fauna' is a time averaged assemblage in which not all listed species coexisted at any given point of time during the

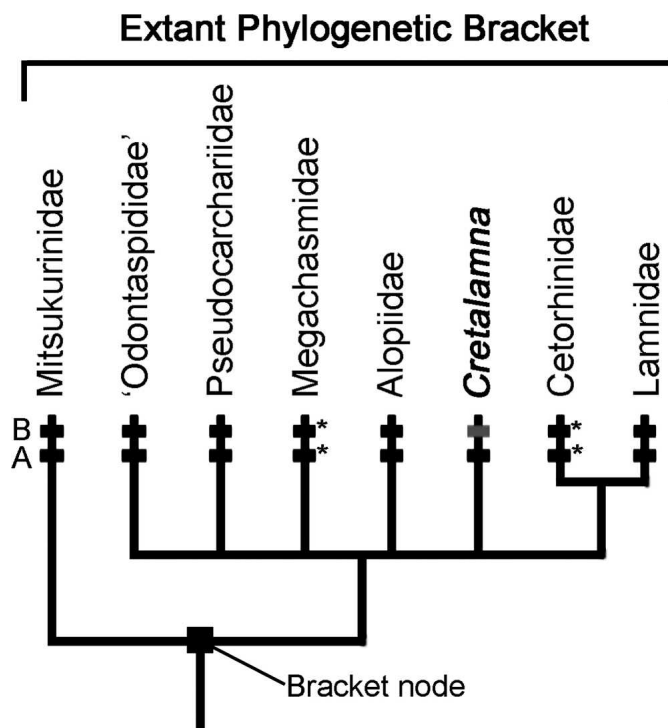

FIGURE 11. Phylogenetic relationships of modern lamniform families with tentative placement of *Cretalamna* to illustrate character distribution of 'lamnoid tooth pattern' (character 'A') and that of dental bullae (character 'B') using extant phylogenetic bracket (EPB) approach (black horizontal bars = present; gray horizontal bar = inferred presence based on EPB; asterisk = assumed to be lost secondarily [see text]).

deposition of the rock member (Stewart, 1990; Shimada and Fielitz, 2006).

The 16 chondrichthyan taxa recognized in the Smoky Hill Chalk include *Cretalamna appendiculata*, but remains of this species are not common in the stratigraphic member particularly compared to some other shark taxa such as *Cretoxyrhina* and *Squalicorax* (Shimada and Fielitz, 2006). Williston (1900a, p. 37; 1900b, p. 247) was the first to suggest the occurrence of *Cretalamna appendiculata* in the Smoky Hill Chalk of Kansas, but no specific specimens of this species were recorded (see also Schultze et al., 1982). To date, only two specimens of *C. appendiculata* from the stratigraphic member are known in literature besides LACM 128126 (Shimada and Fielitz, 2006). They are both from Gove County and are housed in Fort Hays State University, Sternberg Museum of Natural History (FHSM), Hays, Kansas: FHSM VP-14851, an isolated tooth that occurred 3 m below Hattin's (1982) lithostratigraphic Marker Unit 4, and FHSM VP-14852, another isolated tooth occurred at Marker Unit 7 (Hamm et al., 2003). Whereas LACM 128126 is an early Campanian specimen (see above), these two FHSM specimens substantiate the occurrence of the species from the late Coniacian to mid-Santonian parts of the Smoky Hill Chalk. Everhart's (2005, table 13.1) observation also indicates that *C. appendiculata* occurs throughout the rock member.

The occurrence of *Cretalamna appendiculata* in the Smoky Hill Chalk is a small part of the fossil record of the species in Kansas. Its occurrence spans almost the entire range of Late Cretaceous marine deposits including the Dakota Sandstone (Everhart et al., 2004), Graneros Shale (Shimada, 1996), Lincoln Limestone (Liggett et al., 2005), Fairport Chalk (Hattin, 1962: 54), Blue Hill Shale (Shimada, 2006b), Codell Sandstone (Hattin, 1962:97), Fort Hays Limestone (Shimada 1996), and Sharon Springs Shale (Carpenter, 2003). These rocks, including the Smoky Hill Chalk, span chronostratigraphically from the middle Cenomanian to the middle Campanian (Kauffman et al., 1993), and represent diverse depositional settings from near shore (e.g., Dakota Sandstone and Codell Sandstone) to offshore environments (e.g., Lincoln Limestone, Fairport Chalk, and Smoky Hill Chalk) (Hattin et al., 1987).

Globally, *Cretalamna appendiculata* is known from marine rocks that are Albian (Early Cretaceous)—Ypresian (Paleocene) in age (e.g., Cappetta, 1987). This stratigraphic range makes *C. appendiculata* one of the longest persisting lamniform species in the geologic record that occurs across the Cretaceous-Tertiary (K/T) boundary (e.g., see Cappetta, 1987). Its success reflected in its long temporal distribution may be in part due to its ability to inhabit in a wide range of environmental settings. Like the fossil record in Kansas, *C. appendiculata* is found in various marine rocks representing diverse depositional environments (for list of references, see Shimada, Schumacher et al., 2006).

*Cretalamna appendiculata* was probably an ecological generalist that may have also contributed to its long temporal range. Its teeth are mostly broad and are equipped with sharp cutting edges along the principal cusp and lateral cusplets, which are suited for cutting. Although adjacent teeth are juxtaposed without any spaces, a broad root with a pair of wide lateral cusplets offers a large space between the principal cusps of adjacent teeth. Such spacing, which 'broke up' the dental series, probably promoted an effective penetration of the principal cusps into a food item. Unfortunately, no direct evidence (e.g., tooth marks or embedded teeth) for the diet of *C. appendiculata* are known in the fossil record, unlike the record of some contemporaneous sharks such as *Squalicorax* spp. and *Cretoxyrhina mantelli* (Druckenmiller et al., 1993; Schwimmer et al., 1997; Shimada, 1997c; Everhart, 2004, 2005; Shimada and Everhart, 2004; Shimada and Hooks, 2004). However, because the size and morphology of the jaws and teeth of *C. appendiculata* are similar to the modern *Lamna* spp. which commonly feed on small to me-

dium-sized bony fishes (Compagno, 2001), it is plausible that the primary diet of *C. appendiculata* was also small to medium-sized bony fishes. Whereas the estimated TL of 2.3–3.0 m makes *C. appendiculata* a 'medium-sized shark' and is typical for extant lamniforms (e.g., Compagno, 2001), small to medium-sized bony fishes that were likely abundant in seas inhabited by the shark (e.g., Shimada, Schumacher et al., 2006), are considered generalized diets in sharks (e.g., Compagno, 1984). On the other hand, although *Cretoxyrhina mantelli* was successful during the Cenomanian through early Campanian, its body size reaching about 7 m TL (Shimada, Cumbaa et al., 2006) with a set of massive teeth (e.g., Shimada, 1997a) could have made this species prone to the changing selection pressure in its evolving environments. Likewise, *Squalicorax* spp. were successful throughout the Late Cretaceous, but the last species in the genus, *S. pristodontus*, was a massive shark (at least 3 m TL: Shimada and Cicimurri, 2005) with a highly specialized dentition (highly serrated teeth arranged like a saw blade) that could have contributed to its demise at the end of the Cretaceous. However, the exact reason for the extinction of *C. appendiculata* during the Cenozoic is uncertain, although it may be due to competition against many other generalized sharks, such as carcharhiniforms that became dominant in the oceans worldwide around that time (e.g., Cappetta, 1987).

## CONCLUSION

The examination of LACM 128126, a partial skeleton of *Cretalamna appendiculata*, from the Niobrara Chalk of western Kansas, has offered a number of new anatomical information of the species. This study particularly emphasized the reconstruction of dentition and the functional and phylogenetic significance of the reconstructed dentition. However, studying elasmobranch dentitions is not an easy task because of various intraspecific variation parameters one must take into consideration. Intraspecific tooth variations in elasmobranchs can occur in number of tooth rows, in number of accessory cusps (e.g., Gudger, 1937; Sadowsky, 1970; Taniuchi, 1970), at different ontogenetic stages (e.g., Reif, 1976; Shimada, 2002b); between sexes that may also differ between different mating seasons (e.g., McCourt and Kerstitch, 1980; Gruber and Compagno, 1981; Kajiura and Tricas, 1996), among different geographic regions (Lucifora et al., 2003), or in abnormal forms (e.g., Gudger, 1937; Raschi et al., 1982; Kaneko and Goto, 2001). The lack of any consideration of such variations would lead to the 'taxonomic instability' of tooth-based species common to fossil forms (Shimada and Cicimurri, 2006). This study which examines only one individual of *Cretalamna appendiculata* (LACM 128126) does not allow the examination of such potential intraspecific (polymorphic) tooth variations. However, the reconstructed dentition presented here is important because it deciphers the range of intraindividual morphological variation of teeth in *C. appendiculata* that serves as a template for future comparisons. This study demonstrates that an examination of the best available tooth set for a fossil shark along with the examination of jaw morphology, body form, and body size is a powerful strategy in comparative studies of fossil sharks that have implications cascading upwards to the paleoecology of the ancient seas inhabited by *C. appendiculata*.

## ACKNOWLEDGMENTS

Although the data presented here ironically refute some of his interpretations, this paper is dedicated in memory of Dr. Shelton (Shelly) Pleasants Applegate (1928–2005), who was one of the giants in shark paleontology. I thank Shelly, who, in 1992, re-ignited my interest in fossil sharks—a passion once I lost over mammalian paleontology after I graduated high school. This dedication is particularly appropriate because Shelly was putatively involved with the acquisition of the specimen (collected by



M. Bonner) to LACM, and because he regarded *Cretalamna appendiculata* as an important taxon to elucidate lamniform phylogeny (e.g., Applegate and Espinosa-Arrubarrena, 1996). I also thank S. A. MacLeod, G. T. Takeuchi, and J. D. Stewart (LACM) for access to the specimen in their care. I thank M. J. Everhart for useful stratigraphic discussions, and B. L. Beatty for reviewing an early draft of this paper. Comments made by J. Kriwet and M. Siverson significantly improved the quality of this manuscript.

## LITERATURE CITED

- Agassiz, L. 1833–1843 [1835]. Recherches sur les poissons fossiles [5 volumes]. Imprimerie de Patitpierre, Neuchâtel, 1420 pp.
- Antunes, M. T., and H. Cappetta. 2002. Sélaciens du Crétacé (Albien–Maastrichtien) d'Angola. *Palaeontographica Abteilung A* 264: 85–146.
- Applegate, S. P. 1965. Tooth terminology and variation in sharks with special reference to the sand shark, *Carcharias taurus* Rafinesque. Los Angeles County Museum Contributions in Science 86:1–18.
- Applegate, S. P. 1967. A survey of shark hard parts; pp. 37–67 in P. W. Gilbert, R. F. Mathewson and D. P. Rall (eds.), *Sharks, Skates, and Rays*. Johns Hopkins University Press, Baltimore.
- Applegate, S. P. 1970. The vertebrate fauna of the Selma Formation in Alabama. Part VIII: The fishes. *Fieldiana, Geology Memoirs* 3: 385–433.
- Applegate, S. P., and L. Espinosa-Arrubarrena. 1996. The fossil history of *Carcharodon* and its possible ancestor, *Cretolamna*: a study in tooth identification; pp. 19–36 in A. P. Klimley and D. G. Ainley (eds.), *Great White Sharks: the Biology of Carcharodon carcharias*. Academic Press, San Diego.
- Arambourg, C. 1952. Les Vêtrébrés Fossiles des Gisements de Phosphates (Maroc-Algérie-Tunisie). *Notes et Mémoires du Service Géologique de Maroc* 92:1–372.
- Berg, L. S. 1958. System der Rezenten und Fossilen Fischartigen und Fische. *Hochschulbücher für Biologie*, Berlin, 310 pp.
- Bonaparte, C. L. 1838. *Selachorum tabula analytica*. *Nuovi Annali della Scienze Naturali, Bologna* 1(2):195–214.
- Branstetter, S., and J. A. Musick. 1994. Age and growth estimate for the sand tiger in the northwestern Atlantic Ocean. *Transactions of the American Fisheries Society* 123:242–254.
- Cailliet, G. M., L. K. Martin, J. T. Harvey, D. Kusher, and B. A. Welden. 1983. Preliminary studies on the age and growth of blue, *Prionace glauca*, common thresher, *Alopias vulpinus*, and shortfin mako, *Isurus oxyrinchus*, sharks from California waters. National Oceanic and Atmospheric Administration Technical Report, National Marine Fisheries Service 8:179–188.
- Cailliet, G. M., L. J. Natanson, B. A. Welden, and D. A. Ebert. 1985. Preliminary studies on the age and growth of the white shark, *Carcharodon carcharias*, using vertebral bands. *Memoirs of the Southern California Academy of Science* 9:49–60.
- Cappetta, H. 1980. Les sélaciens du Crétacé supérieur du Liban. I: Requins. *Palaeontographica Abteilung A* 168:69–148.
- Cappetta, H. 1987. Chondrichthyes II: Mesozoic and Cenozoic Elasmobranchii; pp. 1–193 in H.-P. Schultze (ed.), *Handbook of Paleichthyology*. Volume 3B. Gustav Fischer Verlag, Stuttgart.
- Carpenter, K. 2003. Vertebrate biostratigraphy of the Smoky Hill Chalk (Niobrara Formation) and the Sharon Springs Member (Pierre Shale); pp. 421–437 in P. J. Harries (ed.), *Approaches in High-Resolution Stratigraphic Paleontology*. Kluwer Academic Publishers, Amsterdam.
- Carvalho, M. R., de. 1996. Higher-level elasmobranch phylogeny, basal squalians, and paraphyly; pp. 35–62 in M. L. J. Stiassny, L. R. Parenti and G. D. Johnson (eds.), *Interrelationships of Fishes*. Academic Press, San Diego.
- Compagno, L. J. V. 1973. Interrelationships of living elasmobranchs; pp. 15–61 in P. H. Greenwood, R. S. Miles and C. Patterson (eds.), *Interrelationships of Fishes*. Zoological Journal of the Linnean Society, London 53.
- Compagno, L. J. V. 1977. Phyletic relationships of living sharks and rays. *American Zoologist* 17:303–322.
- Compagno, L. J. V. 1984. FAO species catalogue. Volume 4. *Sharks of the world*. An annotated and illustrated catalogue of shark species known to date. Food and Agriculture Organization Fisheries Synopsis 125 4:1–655.
- Compagno, L. J. V. 1988. *Sharks of the Order Carcharhiniformes*. Princeton University Press, New Jersey, 486 pp.
- Compagno, L. J. V. 1990. Relationships of the megamouth shark, *Megachasma pelagios* (Lamniformes: Megachasmidae), with comments on its feeding habits. National Oceanic and Atmospheric Administration Technical Report, National Marine Fisheries Service 90: 357–379.
- Compagno, L. J. V. 2001. *Sharks of the world: an annotated and illustrated catalogue of shark species known to date*. Volume 2. Bullhead, mackerel and carpet sharks (Heterodontiformes, Lamniformes and Orectolobiformes). Food and Agriculture Organization Species Catalogue for Fishery Purposes 1(2):1–269.
- Davis, J. W. 1887. The fossil fishes of the chalk of Mount Lebanon, in Syria. *Scientific Transactions of the Royal Dublin Society, Series 2* 3:457–639.
- Druckenmiller, P. S., A. J. Daun, J. L. Skulan, and J. C. Pladzewicz. 1993. Stomach contents in the Upper Cretaceous shark *Squalicorax falcatus*. *Journal of Vertebrate Paleontology* 13(supplement to number 3):33A–34A.
- Everhart, M. J. 2004. Late Cretaceous interaction between predators and prey. Evidence of feeding by two species of shark on a mosasaur. *PalArch* 1:1–7.
- Everhart, M. J. 2005. *Oceans of Kansas—A Natural History of the Western Interior Sea*. Indiana University Press, Bloomington, 322 pp.
- Everhart, M. J., P. A. Everhart, and K. Ewell. 2004. A marine ichthyofauna from the Upper Dakota Sandstone (Late Cretaceous). Abstracts Missouri and Kansas Academies of Science, p. 48.
- Glickman, L. S. 1958. [Rates of evolution in lamnoid sharks]. *Doklady Akademia Nauk, S.S.S.R.* 123:568–571. [Russian]
- Glickman, L. S. 1964. [Sharks of Paleogene and Their Stratigraphic Significance]. Nauka Press, Moscow, 229 pp. [Russian]
- Glickman, L. S., and V. N. Dolganov. 1988. [Shark genus *Lamna*: presence of symphyseal teeth and its systematic position]. *Akademia Nauk, S.S.S.R. (Geology)* 12:111–114. [Russian]
- Goldman, K. J., and J. A. Musick. 2006. Growth and maturity of salmon sharks in the eastern and western North Pacific, and comments on back-calculation methods. *Fishery Bulletin* 104:278–292.
- Goldman, K. J., S. Branstetter, and J. A. Musick. 2006. A re-examination of the age and growth of sand tiger sharks, *Carcharias taurus*, in the western North Atlantic: the importance of ageing protocols and use of multiple back-calculation techniques. *Environmental Biology of Fishes* 77:241–252.
- Gottfried, M. D., L. J. V. Compagno, and S. C. Bowman. 1996. Size and skeletal anatomy of the giant 'megatooth' shark *Carcharodon megalodon*; pp. 55–66 in A. P. Klimley and D. G. Ainley (eds.), *Great White Sharks: The Biology of Carcharodon carcharias*. Academic Press, San Diego.
- Gottfried, M. D., and R. E. Fordyce. 2001. An associated specimen of *Carcharodon angustidens* (Chondrichthyes, Lamnidae) from the Late Oligocene of New Zealand, with comments on *Carcharodon* interrelationships. *Journal of Vertebrate Paleontology* 21:730–739.
- Gruber, S. H., and L. J. V. Compagno. 1981. Taxonomic status and biology of the bigeye thresher, *Alopias superciliosus*. *Fishery Bulletin* 79:617–640.
- Gubanov, Y. P. 1972. On the biology of the thresher shark [*Alopias vulpinus* (Bonaterre)] in the northwest Indian Ocean. *Journal of Ichthyology* 12:591–596.
- Gudger, E. W. 1937. Abnormal dentition in sharks, Selachii. *Bulletin of the American Museum of Natural History* 72:249–280.
- Hamm, S. A., Shimada, K., and Everhart, M. J. 2003. Three uncommon lamniform sharks from the Smoky Hill Chalk (Upper Cretaceous) of western Kansas. *Abstracts, Kansas Academy of Science* 22:30–31.
- Hattin, D. E. 1962. Stratigraphy of the Carlile Shale (Upper Cretaceous) in Kansas. *Kansas Geological Survey Bulletin* 156:1–155.
- Hattin, D. E. 1982. Stratigraphy and depositional environment of Smoky Hill Chalk Member, Niobrara Chalk (Upper Cretaceous) of the type area, western Kansas. *Kansas Geological Survey Bulletin* 225:1–108.
- Hattin, D. E., C. T. Siemers, and G. F. Stewart. 1987. Upper Cretaceous stratigraphy and depositional environments of western Kansas. *Kansas Geological Survey Guidebook* 3:1–102.
- Hay, O. P. 1902. Bibliography and catalogue of the fossil vertebrates of North America. *Bulletin of the United States Geological Survey* 179:1–868

- Huxley, T. 1880. A manual of the anatomy of vertebrated animals. D. Appleton, New York, 431 pp.
- Kajiura, S. M., and T. C. Tricas. 1996. Seasonal dynamics of dental sexual dimorphism in the Atlantic stingray *Dasyatis sabina*. *Journal of Experimental Biology*, 199:2297–2306.
- Kaneko, M., and M. Goto. 2001. A consideration on the abnormal teeth of sharks. *Journal of Fossil Research* 34:18–30.
- Kauffman, E. G., B. B. Sageman, J. I. Kirkland, W. P. Elder, P. J. Harries, and T. Villamil. 1993. Molluscan biostratigraphy of the Cretaceous Western Interior Basin, North America; pp. 397–434 in W. G. E. Caldwell and E. G. Kauffman (eds.), *Evolution of the Western Interior Basin*. Geological Association of Canada Special Paper 39.
- Kent, B. W., and G. W. Powell, Jr. 1999. Reconstructed dentition of the rare lamnoid shark *Parotodus benedeni* (le Hon) from the Yorktown Formation (Early Pliocene) at Lee Creek Mine, North Carolina. *Mosasauro* 6:1–10.
- Kohler, N. E., J. G. Casey, and P. A. Turner. 1996. Length-length and length-weight relationships for 13 species of sharks from the western North Atlantic. National Oceanic and Atmospheric Administration Technical Memorandum, National Marine Fisheries Service Northeast Region 110:1–22.
- Kriwet, J., and S. Klug. 2004. Late Jurassic selachians (Chondrichthyes, Elasmobranchii) from southern Germany: re-evaluation on taxonomy and diversity. *Zitteliana A* 44:67–95.
- Liggett, G. A., K. Shimada, C. S. Bennett, and B. A. Schumacher. 2005. Cenomanian (Late Cretaceous) reptiles from northwestern, Russell County, Kansas. *Paleobios*, 25:9–17.
- Liu, K.-M., P.-J. Chiang, and C.-T. Chen. 1998. Age and growth estimates of the bigeye thresher shark, *Alopias superciliosus*, in northeastern Taiwan waters. *Fishery Bulletin* 96:482–491.
- Liu, K.-M., C.-T. Chen, T.-H. Liao, and S.-J. Joung. 1999. Age, growth, and reproduction of the pelagic thresher shark, *Alopias pelagicus*, in the northwestern Pacific. *Copeia* 1999:68–74.
- Lucifora, L. O., A. L. Cione, R. C. Menni, and A. H. Escalante. 2003. Tooth row counts, vicariance, and the distribution of the sand tiger shark *Carcharias taurus*. *Ecography* 26:567–572.
- Maisey, J. G. 1983. Cranial anatomy of *Hybodus basanus* Egerton from the Lower Cretaceous of England. *American Museum Novitates* 2758:1–64.
- Maisey, J. G., and M. R. de Carvalho. 1997. A new look at old sharks. *Nature* 385:779–780.
- Martin, A. P., and G. J. P. Naylor. 1997. Independent origin of filter-feeding in megamouth and basking sharks (order Lamniformes) inferred from phylogenetic analysis of cytochrome b gene sequences; pp. 39–50 in K. Yano, J. F. Morrissey, Y. Yabumoto and K. Nakaya (eds.), *Biology of Megamouth Shark*. Tokai University Press, Tokyo.
- McCourt, R. M., and A. N. Kerstitch. 1980. Mating behavior and sexual dimorphism in dentition in the stingray *Urolophus concentricus* from the Gulf of California. *Copeia* 1980:900–901.
- Mollet, H. F., and G. M. Cailliet. 1996. Using allometry to predict body mass from linear measurements of the white shark; pp. 81–89 in A. P. Klimley and D. G. Ainley (eds.), *Great White Sharks: The Biology of *Carcharodon carcharias**. Academic Press, San Diego.
- Moss, M. L. 1968. A theoretical analysis of the functional matrix. *Acta Biotheoretica* 18:195–202.
- Motta, P. J. 2004. Prey capture behavior and feeding mechanics of elasmobranchs; pp. 165–202 in J. Carrier, J. Musick and M. Heithaus (eds.), *Biology of Sharks and Their Relatives*, CRC Press, Boca Raton.
- Motta, P. J., and C. D. Wilga. 2001. Advances in the study of feeding behaviors, mechanisms, and mechanics of sharks. *Environmental Biology of Fishes* 60:131–156.
- Nakaya, K. 1971. Descriptive notes on a porbeagle, *Lamna nasus*, from Argentine waters, compared with the north Pacific salmon shark, *Lamna ditropis*. *Bulletin of the Faculty of Fishery, Hokkaido University* 21:269–279.
- Natanson, L. J. 2001. Preliminary investigations into the age and growth of the shortfin mako, *Isurus oxyrinchus*, white shark, *Carcharodon carcharias*, and thresher shark, *Alopias vulpinus*, in the Western North Atlantic Ocean. International Commission for the Conservation of Atlantic Tunas Working Document, Standing Committee on Research and Statistics 01/66.
- Natanson, L. J., N. E. Kohler, D. Ardizzone, G. M. Cailliet, S. P. Wintner, and H. F. Mollet. 2006. Validated age and growth estimates for the shortfin mako, *Isurus oxyrinchus*, in the North Atlantic Ocean. *Environmental Biology of Fishes* 77:367–383.
- Natanson, L. J., J. J. Mello, and S. E. Campana. 2002. Validated age and growth of the porbeagle shark, *Lamna nasus*, in the western North Atlantic. *Fishery Bulletin* 100:266–278.
- Naylor, G. J. P., A. P. Martin, E. G. Mattison, and W. M. Brown. 1997. Interrelationships of lamniform sharks: testing phylogenetic hypotheses with sequence data; pp. 199–218 in T. D. Kocher and C. A. Stepien (eds.), *Molecular Systematics of Fishes*. Academic Press, San Diego.
- Obradovich, J. D., and W. A. Cobban. 1975. A time-scale for the Late Cretaceous of the Western Interior of North America; pp. 31–54 in W. G. E. Caldwell (ed.), *The Cretaceous System in the Western Interior of North America*. Geological Association of Canada Special Paper 13.
- Purdy, R. W., V. P. Schneider, S. P. Applegate, J. H. McLellan, R. L. Meyer, and B. H. Slaughter. 2001. The Neogene sharks, rays, and bony fishes from Lee Creek Mine, Aurora, North Carolina. *Smithsonian Contributions to Paleobiology* 90:71–202.
- Raschi, W., J. A. Musick, and L. J. V. Compagno. 1982. *Hypopriion bigelowi*, a synonym of *Carcharhinus signatus* (Pisces: Carcharhinidae), with a description of ontogenetic heterodonty in this species and notes on its natural history. *Copeia* 1982:102–109.
- Reif, W. E. 1976. Morphogenesis, pattern formation and function of the dentition of *Heterodontus* (Selachii). *Zoomorphologie* 83:1–47.
- Ribot-Carballal, M. C., F. Galvan-Magana, and C. Quinonez-Velasquez. 2005. Age and growth of the shortfin mako, *Isurus oxyrinchus*, from the western coast of Baja California Sur, Mexico. *Fisheries Research* 76:14–21.
- Ride, W. D. L., H. G. Cogger, C. Dupuis, O. Kraus, A. Minelli, F. C. Thompson, and P. K. Tubbs (eds.). 1999. *International Code of Zoological Nomenclature*. Fourth Edition. International Trust for Zoological Nomenclature, British Museum (Natural History), London, 306 pp.
- Ridewood, W. G. 1921. On the calcification of the vertebral centra in sharks and rays. *Philosophical Transactions of Royal Society of London* 210:311–407.
- Russell, D. A. 1988. A check list of North American marine Cretaceous vertebrates including fresh water fishes. *Royal Tyrrell Museum of Palaeontology Occasional Paper* 4:1–58.
- Sadowsky, V. 1970. On the dentition of the sand shark, *Odontaspis taurus*, from the vicinity of Cananea, Brazil. *Boletim do Instituto Oceanografico, Sao Paulo* 18:37–44.
- Schultze, H.-P., J. D. Stewart, A. M. Neuner, and R. W. Coldiron. 1982. Type and figured specimens of fossil vertebrates in the collection of the University of Kansas Museum of Natural History. Part I. Fossil fishes. *University of Kansas Museum of Natural History, Miscellaneous Publications* 73:1–53.
- Schwimmer, D. R., J. D. Stewart, and G. D. Williams. 1997. Scavenging by sharks of the genus *Squalicorax* in the Late Cretaceous of North America. *Palaos* 12:71–83.
- Shimada, K. 1996. Selachians from the Fort Hays Limestone Member of the Niobrara Chalk (Upper Cretaceous), Ellis County, Kansas. *Transactions of Kansas Academy of Science* 99:1–15.
- Shimada, K. 1997a. Dentition of the Late Cretaceous lamniform shark, *Cretoxyrhina mantelli*, from the Niobrara Chalk of Kansas. *Journal of Vertebrate Paleontology* 17:269–279.
- Shimada, K. 1997b. Skeletal anatomy of the Late Cretaceous lamniform shark, *Cretoxyrhina mantelli*, from the Niobrara Chalk in Kansas. *Journal of Vertebrate Paleontology* 17:642–652.
- Shimada, K. 1997c. Paleoecological relationships of the Late Cretaceous lamniform shark, *Cretoxyrhina mantelli* (Agassiz). *Journal of Paleontology* 71:926–933.
- Shimada, K. 2002a. Dental homologies in lamniform sharks (Chondrichthyes: Elasmobranchii). *Journal of Morphology*, 251:38–72.
- Shimada, K. 2002b. Teeth of embryos in lamniform sharks (Chondrichthyes: Elasmobranchii). *Environmental Biology of Fishes* 63:309–319.
- Shimada, K. 2005. Phylogeny of lamniform sharks (Chondrichthyes: Elasmobranchii) and the contribution of dental characters to lamniform systematics. *Paleontological Research* 9:55–72.
- Shimada, K. 2006a (date of imprint 2005). Types of tooth sets in the fossil record of sharks, and comments on reconstructing dentitions of extinct sharks. *Journal of Fossil Research* 38:141–145.
- Shimada, K. 2006b. Marine vertebrates from the Blue Hill Shale Member of the Carlile Shale (Upper Cretaceous: Middle Turonian) in Kansas. *Bulletin of the New Mexico Museum of Natural History* 35:165–175.

- Shimada, K., and G. L. Bell, Jr. 2006. *Coniasaurus* Owen, 1850 (Reptilia: Squamata), from the Upper Cretaceous Niobrara Chalk of western Kansas. *Journal of Paleontology* 80:589–593.
- Shimada, K., and D. J. Cicimurri. 2005. Skeletal anatomy of the Late Cretaceous shark, *Squalicorax* (Neoselachii: Anacoracidae). *Palaeontologische Zeitschrift* 79:241–261.
- Shimada, K., and D. J. Cicimurri. 2006. The oldest record of the Late Cretaceous anacoracid shark, *Squalicorax pristodontus* (Agassiz) from the Western Interior, with comments on *Squalicorax* phylogeny. *Bulletin of the New Mexico Museum of Natural History* 35: 177–184.
- Shimada, K., S. L. Cumbaa, and D. Van Rooyen. 2006. Caudal fin skeleton of the Late Cretaceous shark, *Cretoxyrhina mantelli* (Lamniformes: Cretoxyrhinidae) from the Niobrara Chalk of Kansas. *Bulletin of the New Mexico Museum of Natural History* 35:185–192.
- Shimada, K., and M. J. Everhart. 2004. Shark-bitten *Xiphactinus audax* (Teleostei: Ichthyodectiformes) from the Niobrara Chalk (Upper Cretaceous) of Kansas. *Mosasaurs* 7:35–39.
- Shimada, K., and C. Fielitz. 2006. Annotated checklist of fossil fishes from the Smoky Hill Chalk of the Niobrara Chalk (Upper Cretaceous) in Kansas. *Bulletin of the New Mexico Museum of Natural History* 35:193–213.
- Shimada, K., and G. E. Hooks, III. 2004. Shark-bitten protostegid turtles from the Upper Cretaceous Mooreville Formation of Alabama. *Journal of Paleontology* 78:205–210.
- Shimada, K., B. A. Schumacher, J. A. Parkin, and J. M. Palermo. 2006. Fossil marine vertebrates from the lowermost Greenhorn Limestone (Upper Cretaceous: Middle Cenomanian) in southeastern Colorado. *Journal of Paleontology* Memoir 63:1–45.
- Shirai, S. 1996. Phylogenetic interrelationships of neoselachians (Chondrichthyes: Euselachii); pp. 9–34 in M. L. J. Stiassny, L. R. Parenti and G. D. Johnson (eds.), *Interrelationships of Fishes*. Academic Press, San Diego.
- Siverson, M. 1992. Biology, dental morphology and taxonomy of lamniform sharks from the Campanian of the Kristianstad Basin, Sweden. *Palaeontology* 35:519–554.
- Siverson, M. 1996. Lamniform sharks of the mid Cretaceous Alinga Formation and Beedagong Claystone, Western Australia. *Palaeontology* 39:813–849.
- Siverson, M. 1999. A new large lamniform shark from the uppermost Gearle Siltstone (Cenomanian, Late Cretaceous) of Western Australia. *Transactions of the Royal Society of Edinburgh: Earth Sciences* 90:49–65.
- Siverson, M., and J. Lindgren. 2005. Late Cretaceous sharks *Cretoxyrhina* and *Cardabiodon* from Montana, USA. *Acta Palaeontologica Polonica* 50:301–314.
- Stewart, J. D. 1990. Niobrara Formation vertebrate stratigraphy; pp. 19–30 in S. C. Bennett (ed.), *Niobrara Chalk Excursion Guidebook*. University of Kansas Museum of Natural History and Kansas Geological Survey, Lawrence.
- Stillwell, C. E., and J. G. Casey. 1976. Observations on the bigeye thresher shark, *Alopias superciliosus*, in the western North Atlantic. *Fishery Bulletin* 74:221–225.
- Taniuchi, T. 1970. Variation in the teeth of the sand shark, *Odontaspis taurus* (Rafinesque) taken from the East China Sea. *Japanese Journal of Ichthyology* 17:37–44.
- Thomson, K. S., and D. E. Simanek. 1977. Body form and locomotion in sharks. *American Zoologist* 17:343–354.
- Welton, B. J., and R. F. Farish. 1993. *The Collector's Guide to Fossil Sharks and Rays from the Cretaceous of Texas*. Before Time, Lewisville, Texas, 204 pp.
- Wilga, C. D. 2005. Morphology and evolution of the jaw suspension in lamniform sharks. *Journal of Morphology* 265:102–119.
- Williston, S. W. 1900a. Some fish teeth from the Kansas Cretaceous. *Kansas University Quarterly* 9:27–42.
- Williston, S. W. 1900b. Cretaceous fishes: selachians and pycnodonts. *Kansas University Geological Survey* 4:237–256.
- Wintner, S. P., and G. Cliff. 1999. Age and growth determination of the white shark, *Carcharodon carcharias*, from the east coast of South Africa. *Fishery Bulletin* 97:153–169.
- Witmer, L. M. 1997. The evolution of the antorbital cavity of archosaurs: a study in soft-tissue reconstruction in the fossil record with an analysis of the function of pneumaticity. *Memoirs of the Society of Vertebrate Paleontology, Journal of Vertebrate Paleontology* 17(supplement to number 1):1–73.
- Woodward, A. S. 1911. *The fossil fishes of the English Chalk, Part VI*. *Monographs of the Palaeontographical Society* 64:185–224.

Submitted June 2, 2006; accepted February 11, 2007.

#### APPENDIX 1. Dental measurements of each tooth type of *Cretalamna appendiculata* in LACM 128126.

Tooth type	TH	TW	TT	CH	CW	CT	LCH	PCH	PCW	MCL	DCL
Upper											
'S1'*	—	—	—	3.3+?	3.9+?	1.9	—	3.3	3.9	4.3	5.1
'S2'*	7.8	5.5	3.5	5.0	5.1	2.5	1.9	4.1	4.1	4.4	5.7
A1	19.5	13.4	6.3	15.5	11.7	6.3	2.9	13.2	8.5	14.3	13.7
A2	18.9	17.5	5.5	15.0	16.3	4.5	3.4	12.2	9.7	14.8	12.2
I1	14.5	17.7	5.1	10.7	16.9	4.2	3.4	8.5	9.8	12.2	9.0
L1	17.0	20.4	5.5	13.5	19.5	4.3	3.7	11.0	9.8	14.2	10.9
L2	16.9	19.5	5.5	13.4	19.3	4.5	4.3	10.7	10.0	13.9	10.8
L3	16.9	19.5	5.5	13.3	18.5	4.4	4.2	10.0	9.8	13.4	10.1
L4	15.3	17.8	5.0	11.5	17.0	4.0	3.5	8.8	8.6	10.7	9.0
L5	12.8	16.0	4.5	9.0	15.3	3.6	3.2	6.9	7.5	9.0	7.0
L6	9.3	15.1	3.8	6.4	15.1	3.1	3.0	4.2	6.7	7.7	4.3
L7	8.6	13.2	3.7	6.1	12.9	2.9	2.9	3.9	5.7	6.2	3.8
L8	7.4	12.4	3.3	5.0	12.4	2.3	2.8	2.6	5.5	5.0	2.8
L9	5.7	10.3	3.0	3.7	10.3	2.1	2.3	1.9	3.7	4.0	1.9
L10	5.0	9.6	2.7	3.0	9.2	1.9	1.7	1.4	3.7	3.6	1.3
Lower											
a1	19.7	15.0	6.9	15.6	13.2	5.1	3.0	13.0	8.6	14.0	13.6
a2*	19.9	17.0	6.9	16.0	14.9	5.1	2.8	13.3	10.0	15.4	13.8
i1	17.0	16.0	5.3	13.5	15.3	5.3	3.4	10.4	8.4	11.5	10.9
I1	16.0	17.5	4.9	12.5	16.4	4.0	3.8	9.5	9.3	11.1	10.2
I2	16.3	17.3	4.9	12.5	15.9	3.9	3.7	10.1	8.8	11.4	10.4
I3	14.7	17.0	4.8	11.0	15.9	3.6	3.4	8.9	8.5	11.4	9.0
I4	12.6	16.1	4.6	9.8	15.9	3.5	3.3	6.7	7.8	9.7	6.5
I5	8.7	13.1	2.6	6.2	12.5	2.4	2.9	4.0	5.5	6.3	3.9

All measurements in millimeters; see Fig. 4 for measured variables; (see Figs. 7–10 for abbreviations of tooth types).

**Abbreviations:** TH, tooth height; TW, tooth width; TT, tooth (labiolingual) thickness; CH, crown (maximum enameloid) height; CW, crown (maximum enameloid) width; CT, crown (labiolingual) thickness; LCH, lateral cusplet height; PCH, principle (main) cusp height; PCW, principle (main) cusp width; MCL, mesial cutting edge length; DCL, distal cutting edge length.

APPENDIX 2. Published regression equations correlating vertebral size (vertebral diameter [VD] or vertebral radius [VR]; unless otherwise noted, all in millimeters) with total length (TL; in centimeters) in modern lamniforms, and TL estimation (TL<sub>est</sub>; in centimeters) for described individual of *Cretalamna appendiculata* (LACM 128126) by substituting 40 mm for VD or 20 mm for VR in each respective equation.

Taxon (mean TL <sub>est</sub> ) reference	Equation [ $r^2$ ; $n$ ; TL conversion (where needed)]	TL <sub>est</sub>
<i>Carcharias taurus</i> (312) Branstetter and Musick (1994)	TL = 44.4 + 16.7 · VR [0.84; 40; -]	378
Goldman et al. (2006)	TL = 36.8 + 10.8 · VR [0.97; 96; -]	253
<i>Alopias pelagicus</i> (428) Liu et al. (1999)	PCL = 48 + 8.8 · VR [?; 413; TL = 2.3 + 1.9 · PCL]	428
<i>Alopias superciliosus</i> (409) Liu et al. (1998)	PCL = 49.9 · VR <sup>0.493</sup> [0.75; 321; TL = 15.2 + 1.8 · PCL]*	409
<i>Alopias vulpinus</i> (511) Cailliet et al. (1983)	TL = 59.7 + 13.3 · VD [0.90; 67; -]	592
Natanson (2001)	FL = 31.2 + 10.3 · VR [0.93; 13; TL = (FL - 9.6)/0.53]	429
<i>Carcharodon carcharias</i> (269) Cailliet et al. (1985)	TL = 35.9 + 5.7 · VD [0.97; 18; -]	264
Gottfried et al. (1996)	TL = 22 + 5.8 · VD [0.97; 16; -]	254
Wintner and Cliff (1999)	PCL = (VD/10 + 0.3)/0.02 [0.96; 114; TL = 5.2 + 1.3 · PCL]	285
Natanson (2001)	FL = 21.0 + 11.8 · VR [0.94; 14; TL = (FL + 0.06)/0.94†]	273
<i>Isurus oxyrinchus</i> (307) Cailliet et al. (1983)	TL = 31.6 + 7.1 · VD [0.91; 43; -]	316
Natanson (2001)	FL = 25.0 + 12.1 · VR [0.98; 19; TL = (FL + 1.7)/0.93‡]	289
Ribot-Carballal et al. (2005)	TL = 19.6 + 15.6 · VR [0.91; 109; -]	332
Natanson et al. (2006)	FL = 18.5 · VR <sup>0.893</sup> [0.98; 236; TL = (FL + 1.7)/0.93]	291
<i>Lamna ditropis</i> (283) Goldman and Musick (2006)	PCL = 21.0 + 10.6 · VR [0.90; 182; TL = 15.2 + 1.15 · PCL]	283
<i>Lamna nasus</i> (302) Natanson (2002)	ln(FL) = 3.0 + 0.88 · lnVR [0.94; 575; TL = FL/0.93]	302

**Other abbreviations:**  $r^2$ , correlation coefficient;  $n$ , sample size; **PCL**, pre-caudal length; **FL**, fork length.

\*Data from females and males are combined and averaged.

†From Mollet and Cailliet (1996)

‡From Kohler et al. (1996).